

# User Manual



## Professional Thermocouple Thermometer with Four Type K Inputs, Data Logging, and Optional Infrared Wand

with NIST-Traceable Calibration

### Model 20250-20

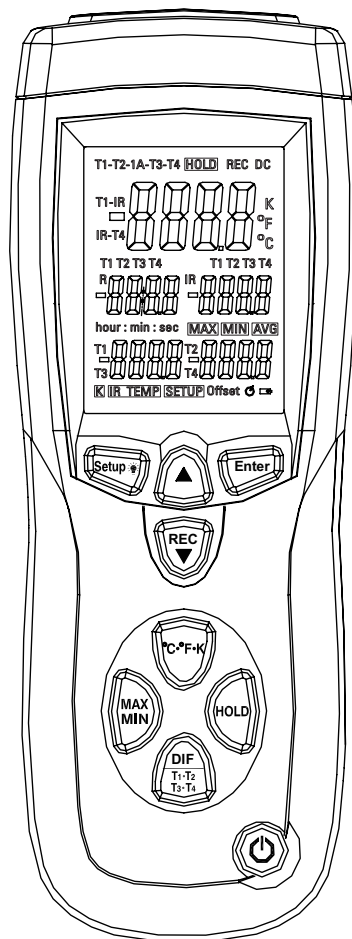

## **Introduction**

The Digi-Sense Professional Thermocouple Thermometer (Model 20250-20) with Four Type K Inputs, Data Logging, and Optional Infrared Wand offers fast response and high accuracy. This heavy-duty meter works with up to four type K thermocouples and one optional infrared probe\*. Advanced features include data logging, USB interface, relative time clock, offset compensation, temperature differential, data Hold, Max/Min/Avg readings, and automatic power-off. The instrument is fully tested and calibrated to NIST-traceable standards. Careful use of this meter will provide years of reliable service.

## **Unpacking**

Check individual parts against the list of items below. If anything is missing or damaged, please contact your instrument supplier immediately.

1. Meter
2. Four type K flexible probes
3. USB cable
4. Software
5. Carrying case
6. One 9 V battery
7. User manual
8. NIST-traceable calibration report with data

\*Optional infrared wand (model 20250-24) must be ordered separately.

## **Key Features**

- Large backlit display shows any combination of T1, T2, IR, T3, T4, T1–T2, T1–IR, T2–IR, T3–T4, IR–T3, IR–T4; plus Max, Min, and Avg readings
- Relative time clock on Max/Min/Avg provides a time reference for major events
- Electronic Offset function allows compensation of thermocouple errors to maximize overall accuracy
- USB interface
- Data logging capacity of 10,000 sampling points
- User-selectable readout in °C, °F, or Kelvin (K)
- 0.1°C / 0.1°F / 0.1 K resolution
- Automatic power-off mode conserves battery life
- Accepts a wide variety of thermocouple type K probes (up to four)
- Optional IR wand available for safe, noncontact temperature measurements

## Meter Description

1. Thermocouple type K input (T1, T2, T3, T4)
2. LCD
3. **Enter** button
4. Up ▲ button
5. **Rec/▼** button
6. °C/°F/K button
7. **HOLD** button
8. **DIF/T1-T2-T3-T4** button
9. **Power on/off** button
10. **MAX/MIN** button
11. **Setup /**  **Backlight** button
12. IR input\*

\*Optional infrared wand (model 20250-24) must be ordered separately.

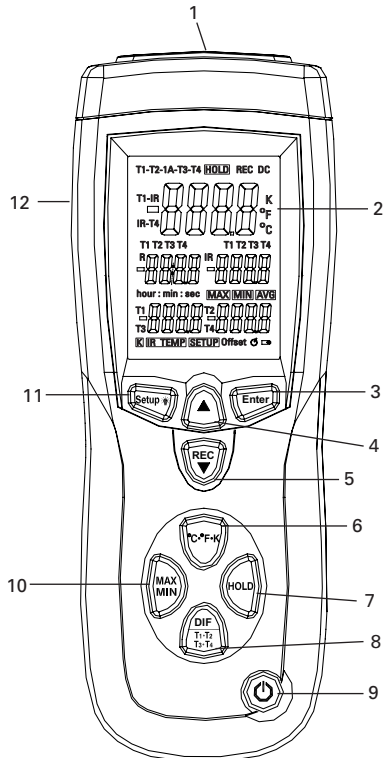

# Display Layout

1. Primary temperature display
2. Tertiary display (IR temperature or recording time)
3. Min:Sec or Hour:Min display
4. T1 or T3 temperature display
5. Thermocouple type icon
6. Infrared IR TEMP icon (requires Optional IR wand sku number 20250-24)
7. SETUP mode icon
8. Offset icon
9. Auto power-off icon
10. Low-battery icon
11. T2 or T4 temperature display
12. MAX, MIN, AVG icons
13. Secondary display (T1, T2, T3, or T4 reading)
14. Temperature unit icons (K, °F, °C)
15. Data transmitting to PC icon
16. Recording (data logging) icon
17. Data HOLD icon

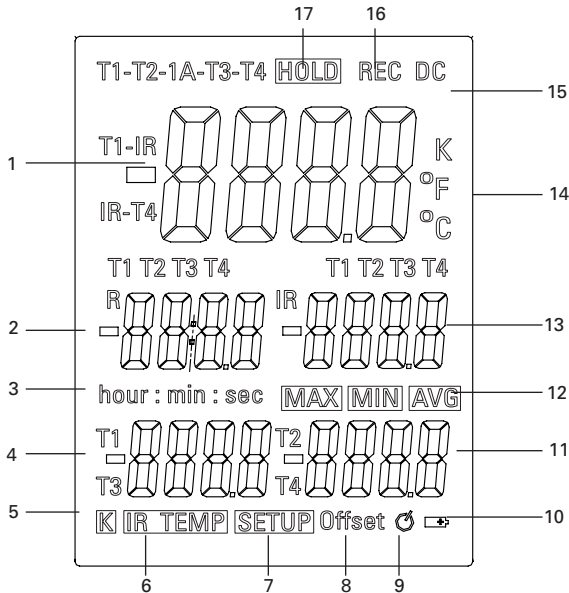

## Setup and Operation

1. Press **Power on/off** button to turn the unit on. The value immediately shown is the number of data logging sample points remaining (from 10,000 to 0). After one second, the display will then switch to the temperature measurement reading mode.
2. Press **MAX/MIN** button to step through the maximum, minimum, and average readings. To exit the Max/Min/Avg mode, press and hold **MAX/MIN** button for three seconds to resume normal operation.
3. Press **°C/°F/K** button to switch between Celsius (°C), Fahrenheit (°F), and Kelvin (K).
4. Press **HOLD** button to freeze or unfreeze the displayed readings. The screen shows the **HOLD** icon.
5. Press **DIF/T1-T2-T3-T4** button to toggle between showing the T1, T2, IR, T1-T2, T1-IR, and T2-IR (differential temperature measurement) in the primary, secondary, and tertiary display. Press and hold the **DIF/T1-T2-T3-T4** button for two seconds to toggle between showing T3, T4, IR, T3-T4, IR-T3, IR-T4 in the primary, secondary, and tertiary display. Press the **DIF/T1-T2-T3-T4** button again for two seconds to exit.
6. Press **Setup/Backlight** button to turn on the backlight. Press it again to turn off the backlight. Press **Setup/Backlight** button and hold for three seconds to enter or exit the Setup mode. (See "Changing Setup Options")
7. Press **▲** or **Rec/▼** button to scroll to the Setup option you want to change. Press **▲** button to increase the displayed setting.
8. Press **Rec/▼** button to start recording and press again to stop recording. If entering a Setup option, scroll to the Setup option you want to change. Press **Rec/▼** button to decrease the displayed setting.
9. Press **ENTER** button to enter a Setup option. Press **ENTER** button again to store the new setting into memory.

### Using Thermocouple Input(s)

1. Plug the type K thermocouple(s) into the T1, T2, T3, and T4 input connector(s).
2. Turn meter on. After one second, the thermometer displays the first reading. If no thermocouple is plugged into the selected input or if the thermocouple is "open," the display will show "- - - -".

### Using Infrared Input

1. Purchase optional infrared wand model number 20250-24 (shown at right).
2. Plug the IR wand into the IR input connector on side of meter; "IR - - - -" will show on screen. If the IR wand is not connected, "IR - - - -" is not shown on the screen.
3. Press the **SCAN** button on the IR wand to begin measuring and the IR temperature is shown on the screen.

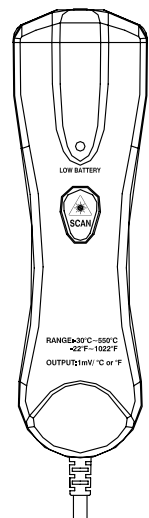

## Changing Setup Options

Use the Setup mode to change offset, sample rate, time, clear data logging memory, and sleep mode settings. The thermometer stores the settings in its memory.

Option	Menu item	Settings
Offset	T1, T2, IR, T3, T4	T1, T2, IR, T3, or T4 offset
Sample rate	rAt	Sampling of recording
Time setting	tiE	Show the time or set the time
Clear data logging memory	CLR	Clear the memory operation
Sleep mode	SLP	On (sleep mode on) or Off (sleep mode off)

### Entering or Exiting Setup Mode

When the thermometer is in **Setup** mode, the display shows the **SETUP** icon. Press and hold **Setup** button for five seconds to enter or exit the Setup mode.

### Changing a Setup Option

1. Press **▲** or **Rec/▼** button scroll to the Setup option you want to change.
2. Press **Enter** button to indicate that you want to change this setting.
3. Press **▲** or **Rec/▼** button until the setting you want to use appears on the display.
4. Press **Enter** button to store the new setting into memory.

**Note:** Setup is disabled in the Max/Min/Avg and Recording modes.

### Offset Function

The primary display shows the temperature plus the offset and the secondary display shows the offset. You can store individual offsets for T1, T2, IR, T3, and T4 (Fig. 1).

### Using the Offset to Adjust for Probe Errors

Use the offset option in Setup mode to adjust the thermometer's readings to compensate for the errors of a specific thermocouple and IR temperature. The allowable adjustment range is  $\pm 9.0^{\circ}\text{F}$  or  $\pm 5.0^{\circ}\text{C}$ .

1. Plug the thermocouple into the input connector.
2. Place the thermocouple in a known, stable temperature environment (such as an ice dry well calibrator).
3. Allow the readings to stabilize.
4. In the Setup mode, change the offset until the primary reading matches the calibration temperature. (See "Changing Setup Options")

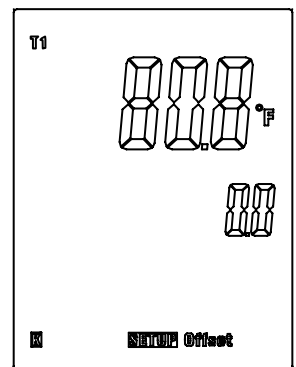

Fig. 1

## Sample Rate Function

The secondary display shows the sample rate of the temperature data recording. When the meter is powered on, the default sample rate is 1 second. The secondary display shows "00 01" in minutes, then seconds (Fig. 2).

1. Press **°C/°F/K** button until the value you wish to change is flashing.
2. Press **▲** or **Rec/▼** button until the setting you want to use appears on the display.
3. Press **Enter** button to store the new setting into memory.

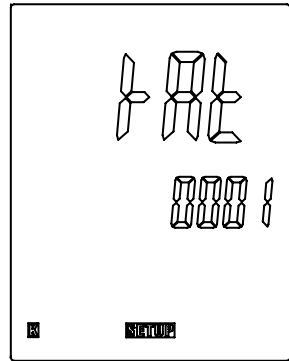

Fig. 2

## Time Setting Function

1. While in Setup mode, scroll to the **time** setting option screen. The primary display shows the year; the secondary display shows the month and the day; and the tertiary display shows the hour and minute. In Fig. 3, the display shows the date and time "2007-08-16 18:55". If no adjustment is needed, press **Enter** button to exit time setting.
2. Set the time. The adjust order is year, month, day, hour, minute. Press **°C/°F/K** button until the value you wish to change is flashing.
3. Press **▲** or **Rec/▼** button until the setting you want to use appears on the display.
4. Press **Enter** button to store the new setting into memory.

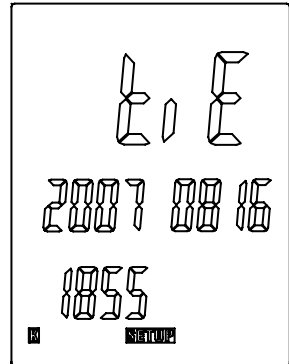

Fig. 3

## Clear Memory Operation

Immediately after turning on the meter, the first value shown is the number of data logging sample points remaining (from 10,000 to 0). Once the memory is full, the first value shown will be "FULL" rather than a number. At this point, you are no longer able to record until the memory is cleared.

1. Press and hold **Setup** button for three seconds to enter the Setup mode. While in Setup mode, the display shows the **SETUP** icon.
2. Use the **▲** and **Rec/▼** buttons to scroll to the **CLR memory** option screen. The screen indicates the number of sample points remaining (Fig. 4).

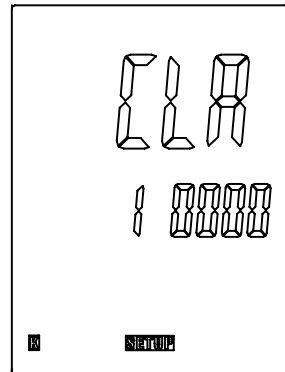

Fig. 4

## Clear Memory Operation (Continued)

3. Press **Enter** button and "SURE No" will appear on the screen.
4. Press the **▲** or **Rec/▼** button until the display shows "SURE YES", indicating the memory will be cleared.
5. Press **Enter** button to select the "SURE YES" setting and clear the memory. Data logging capacity now returns to 10,000 sample points.

## Auto Power-Off (APO)/Sleep Mode

The meter's default mode is to automatically shut off after 20 minutes of non-use. To de-activate the auto power-off mode, enter the Setup mode.

1. While in Setup mode, press **▲** or **Rec/▼** button to scroll to the **SLP** option screen.
2. Press **Enter** button to display "On" (Fig. 5).
3. Use the **▲** or **Rec/▼** button to toggle between "On" (sleep mode on) or "Off" (sleep mode off).
4. Press **Enter** button to store the new setting into memory.

**Note:** Meter defaults back to "On" once meter is powered off.

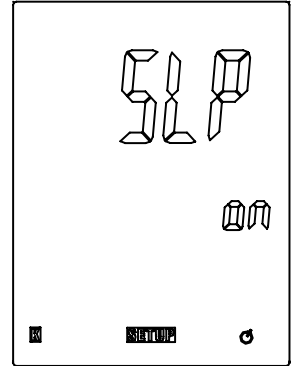

Fig. 5

## Displaying Temperatures

1. Press **°C/°F/K** button to switch between Celsius (°C), Fahrenheit (°F), and Kelvin (K) temperature scales.
2. Hold or attach the thermocouple(s) to the measurement location. The temperature reading appears in the primary display.

**Note:** The display shows "- - -" when a thermocouple is not connected. The display shows "OL" (overload) when the temperature being measured is outside the thermocouple's valid range.

## Hold Function

1. Press **HOLD** button to freeze the readings on the display. The screen shows the **HOLD** icon.
2. Use the **DIF/T1-T2-T3-T4** button to toggle between showing the T1, T2, IR, T1-T2, T1-IR, and T2-IR (differential temperature measurement) in the primary, secondary, and tertiary display. Press and hold the **DIF/T1-T2-T3-T4** button for two seconds to show T3, T4, IR, T3-T4, IR-T3, and IR-T4 in the primary, secondary, and tertiary display. Press and hold the **DIF/T1-T2-T3-T4** button again for two seconds to return.
3. Press **HOLD** button again to turn off the HOLD function and resume measuring.



## Viewing the MAX, MIN, and AVG Readings

1. Press **MAX/MIN** button to step through the maximum (MAX), minimum (MIN), and average (AVG) readings. The elapsed time since entering MAX/ MIN/AVG mode, or the time at which the minimum or maximum occurred, appears on the display.
2. Press and hold the **MAX/MIN** button for three seconds to exit the Max/Min/Avg mode and return to normal operation.

## Recording/Data Logging Operation (Meter)

1. Press **Power on/off** button to turn the unit on. The first value immediately shown is the number of data logging sample points remaining (Fig. 6).
2. Press **Rec/▼** button to begin recording; the REC icon will be appear to indicate the meter is recording data measurements.
3. To stop recording, press and hold **Rec/▼** button for three seconds until the REC icon is no longer shown.
4. **Note:** A maximum of 10,000 sample points is available (Fig. 6). As you log temperature readings, this value will be lower each time you turn on the meter. When the memory is full (with 0 sample points remaining), the first value shown will be "FULL" rather than a number. Or if you try to record, the **REC** icon will flash five times and disappear. At this point, you are no longer able to record until the memory is cleared. (See "Changing Setup Options", "Clear Memory Operation" on pages 7–8.)

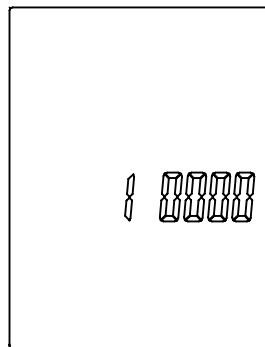

Fig. 6

## Recording/Data Logging Operation (Software)

1. First install software on PC following the set up wizard (see "Software Installation" on next page). Once software is successfully installed, the data logging software icon shortcut will be automatically placed on your PC desktop.
2. Connect thermometer to your PC via the supplied USB cable.
3. Power the meter on.
4. Open the installed Data Logger Software by double-clicking on the icon on your PC desktop.
5. In the Data Logger Setting menu, confirm time and select date format, sampling rate, memory full directions, auto power-off status, and start method; then select "OK". **You must set these parameters before meter will record measurements.**
  - a. **Note:** Manual start method is controlled by user pressing REC button on instrument. Automatic start method will activate recording via the software instantly once selected.

## **Recording/Data Logging Operation (Software) continued**

6. In manual record mode, press and hold **Rec/▼** button on the meter for three seconds until **REC** icon is indicated on the screen, indicating that recording function has been activated. Upon completion of desired data logging of measurements, press and hold **Rec/▼** button for three seconds until **REC** icon disappears from the screen, indicating data logging has been deactivated.
7. To download the data to your PC, select RealTime(R) in the menu bar and click run. The software screen will display the data being downloaded from the meter. Upon completion of downloading the data to the PC, the data results will be displayed graphically.
8. To save the measurement data to your PC, select the "Data List" tab to open the list of measurements recorded. Select "File" icon from the menu bar and save data to desired location on your PC. **Note:** Data will be saved in an Excel® format that will include all summary information as captured on the "Data Summary" tab.
9. To print recorded data, simply select the "print" icon on the menu bar.
10. On the menu bar, select HELP to read detailed information on the capabilities of this software.

## **Software Installation**

1. Insert the CD into the PC.
2. Double-click the set up.exe file to launch the software installation program.
3. Follow the installation wizard to complete the installation.
4. If the USB driver needs to be updated or driver error message is received, please go to the folder with driver on the CD and double-click the file CP210xVCPInstaller.exe to update the driver.
5. Upon successful installation of the software, the software icon shortcut will be automatically placed on your PC desktop.

# Specifications

<b>Range</b>	
Temperature, external type K thermocouple	-328 to 2501°F (-200 to 1372°C)
<b>Resolution</b>	
Temperature display	0.1 (<1000) or 1 (≥1000)
<b>Accuracy</b>	
T1, T2, T3, T4	±[0.15% reading + 1.8°F (1°C)] above -148°F (-100°C) ±[0.5% reading + 3.6°F (2°C)] below -148°F (-100°C)
T1-T2, T3-T4	±[0.5% reading + 1.8°F (1°C)]
IR temperature	±[2.0% reading + 3.6°F (2°C)] above 14°F (-10°C) ±9°F (5°C) below 14°F (-10°C)
T1-IR, T2-IR, IR-T3, IR-T4	±[2.0% reading + 5.4°F (3°C)] above 14°F (-10°C) ±11°F (6°C) below 14°F (-10°C)

Auto power-off	Unit shuts off automatically after 20 minutes to conserve battery life
Operating temperature	32 to 122°F (0 to 50°C)
Storage temperature	14 to 122°F (-10 to 50°C)
Weight	9.8 oz (280 g)
Dimensions	8" x 3" x 2" (20.1 x 7.5 x 5 cm)
Power	One 9 V battery

## Optional Infrared Wand (Model 20250-24)

Temperature range	-31 to 1022°F (-35 to 550°C)
Resolution	1 mV per °F/°C
Basic accuracy	±2% or ±4°F (2°C)
Response time	Less than 500 ms
Optical resolution (Distance-to-Spot ratio)	8:1
Plug diameter	Banana plug: 0.16" (4 mm)
Dimension	6½" x 2" x 1½" (16.4 x 5 x 4 cm)
Power	One 9 V battery

## **Maintenance, Recalibration, and Repair**

### **Cleaning and storage**

- The meter should be cleaned with a damp cloth and mild detergent when necessary. Do not use solvents or abrasives.
- Store the meter in an area within the storage range indicated in the Specifications chart earlier in this manual.

### **Battery Replacement**

When the battery power falls low, the **low-battery** icon will appear on the screen. Replace the 9 V battery in the rear battery compartment by removing the cover. Ensure that the cover is securely refastened when finished.

**It is recommended that Digi-Sense products are calibrated annually** to ensure proper function and accurate measurements; however, your quality system or regulatory body may require more frequent calibrations. To schedule your recalibration, please contact InnoCal, an ISO 17025 calibration laboratory accredited by A2LA.



**Phone:** 1-866-INNOCAL (1-866-466-6225)

**Fax:** 1-847-327-2993

**E-mail:** [sales@innocalsolutions.com](mailto:sales@innocalsolutions.com)

**Web:** [InnoCalSolutions.com](http://InnoCalSolutions.com)

### **For Product and Ordering Information, Contact:**

