



Adam Equipment

ADAM THERMAL PRINTER 2

Easy Reference:

Serial number of the printer:	
Model of the product linked to this printer:	
Software revision number of the product linked to the printer:	
Serial number of the product linked to the printer:	
Date of Purchase:	
Name of the supplier and place:	

Statement

- ☛ This product is Class A and may cause radio interference in the domestic environment. In this case, it may be necessary for the user to take practical measures against its interference.
- ☛ The content of this manual is not allowed to be changed without permission. Adam Equipment reserves the right to improve the product on the software and hardware. For further information about the products, please contact Adam Equipment and its authorized distributors.

Safety information

To use your printer effectively and safely, please follow the following rules.

☛ Before using

- | |
|---|
| <ul style="list-style-type: none">•Please read this user manual carefully before using the printer to master the correct use method•Please keep this user's manual in a convenient place so that you can refer to it and find answers at any time. |
|---|

☛ Safety precautions

If you ignore the following precautions and use the printer incorrectly, it may be damaged.

△ attention

- | |
|--|
| <ul style="list-style-type: none">•In case of paper jam, be sure to turn off the power and wait 10 seconds for the head to cool down before removing the paper jam.•Do not place the product in a humid or dusty environment.•Do not press hard, do not pile up. |
|--|

☛ Safety precautions

Paper roll

- Paper rolls that meet the requirements of this manual must be used.
- Do not select the paper reel whose end is glued on the cardboard inner shaft, otherwise the printer will not be able to measure the end of the paper reel correctly, and it may cause damage to the printing mechanism. Do not use paper roll without a cardboard inner shaft, otherwise when print to the end of the paper, because the weight of the paper roll is not enough, it may cause paper jam.

CONTENTS





(P.N. 3.12.6.6.15784, Revision A, July 2020)

1.	INTRODUCTION	2
2.	SETTING UP.....	3
3.	TECHNICAL SPECIFICATIONS.....	4
	Chapter 1 Overview.....	4
1.1	Main Technical Specifications	4
1.2	Printing paper	4
1.3	Print characters	5
1.4	Interface type.....	5
1.5	Control command	5
1.6	Power supply and operating environment requirements	5
1.7	Dimensions and weight	6
	Chapter 2 Installation and Operation	6
2.1	Printer appearance	6
2.2	Control panel	6
2.3	Indicator light and key operation	7
2.4	The installation of the paper	7
2.5	Interface connection	8
2.5.1	Serial interface connection	8
2.5.2	Parallel interface connection.....	11
2.5.3	Cashbox interface	12
2.6	The head clean.....	13
	Chapter 3 Troubleshooting.....	13
3.1	Command.....	14
3.2	Print command.....	14
3.2.1	Print command.....	14
3.2.2	Line spacing set command.....	15
3.2.3	Character print command	15
3.2.4	Special control command	17
3.2.5	Bar code command.....	17
3.2.6	Other commands.....	20
	Appendix 1: CODE128 barcode.....	20
4.	PRINTER INSTALLATION AND OPERATION	24
4.1	Packing List	24
	WARRANTY STATEMENT.....	25

1. INTRODUCTION

- The Adam Thermal Printer 2 is a general purpose thermal tally roll printer specifically designed to work with the Adam series of balances.
- The printer comes preset to work with the default RS-232 interface found on the Adam balances but can easily be changed to work on other equipment as well.
- The printer is easy to use with only an On/Off switch and a paper feed button.

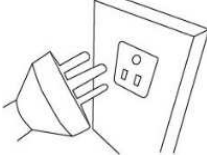
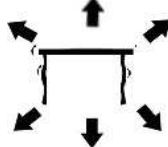
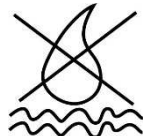
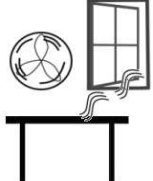
2. SETTING UP

	<p>Avoid extremes of temperature. Do not place in direct sunlight or near air conditioning vents.</p>
	<p>Make sure the scale is located on a strong table and free from vibration.</p>
	<p>Avoid unstable power sources. Do not use near large users of electricity such as welding equipment or large motors. Do not mix batteries and use only the factory approved power adapter supplied with the machine. Do not use batteries and the DC adapter at the same time.</p>
	<p>Keep free from vibration. Do not place near heavy or vibrating machinery.</p>
	<p>Avoid high humidity that might cause condensation. Keep away from direct contact with water. Do not spray or immerse the scales in water.</p>
	<p>Do not place near open windows, air-conditioning vents or fans that may cause a draft and unstable readings.</p>
	<p>Avoid operating in high static areas, or weighing high static materials, such as plastics or powders, as this may damage electronics and affect measurements. Use grounding mats or bonding straps to reduce potential</p>

IMPORTANT

- Clean the print head regularly to avoid poor print quality, only attempt to clean when the printer is off and the thermal print head has had time to cool. Clean with a soft cloth using diluted alcohol.
- Do not print without paper, otherwise it will seriously damage the thermal print head.
- If you do not use the printer for a long time, disconnect the power supply from the printer power adapter.
- The user shall not dismantle the printer for maintenance or modification without authorization.
- It is recommended to use high-quality printing paper.
- When unplug the connector, make sure the printer power is turned off.
- When plug/unplug the printer power cord, hold the arrow marked on the printer power connector.

3. TECHNICAL SPECIFICATIONS

Chapter 1 Overview

1.1 Main Technical Specifications

item	parameter
Print method	Direct thermal line printing
Print speed	About 50mm/second
Printing paper width	57.5±0.5mm
Print density	8 points/mm, 384 points/row
Effective print width	48mm
Paper Handling	Hand to tear
Lack of paper detection	Photoelectric sensor
Print head life	50KM

1.2 Printing paper

item	parameter
Paper roll type	Thermal paper
Paper specifications	Paper width: 57.5±0.5mm; max external diameter: φ60mm;
	min inner diameter: φ10mm ; Paper thickness: 53~60g/m ²

1.3 Print characters

item	parameter
ANK character set	12x24 point, 1.25 (width) x3.00 (height) mm
National standard I, II	24x24 point
Chinese character database	3.00 (width) x3.00 (height) mm

1.4 Interface type

item	parameter
Serial interface	D-SUB 25 Socket (hole), support RTS/CTS; Baud rate: 4800bps
	Data structure: 1 start bit +8 data bit +1 or more stop bit
Parallel interface	8-bit parallel port, BUSY handshake protocol, PE paper test, interface socket is adopted
	D-SUB 25 Socket (hole)
Cashbox control	DC12V, 3A, 6 wire RJ-11socket

1.5 Control command

item	parameter
Bit map print command	Support different density bit map and lower graphics printing
Character print command	It supports the printing of ANK characters, custom characters and Chinese characters with double width and double height, and the character line spacing is adjustable.

1.6 Power supply and operating environment requirements

item	parameter
power supply	DC12V, 3A
Working temperature	5~40°C
Working relative humidity	10~80%
Storage temperature	-20~60°C

Storage relative humidity	10~90%
---------------------------	--------

1.7 Dimensions and weight

item	parameter
dimensions	197 (L) × 120 (W) × 102 (H) mm
weight	644g (Paper rolls are not included)

Chapter 2 Installation and Operation

2.1 Printer appearance



Figure 2-1. Printer appearance

2.2 Control panel

There is a button and two indicator lights on the panel of ATP2 printer, as shown in Fig. 2-2.1:

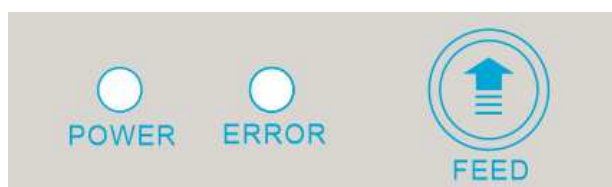

Figure 2-2.1 Schematic diagram of the control panel

2.3 Indicator light and key operation

Indicator light:

☐ Power light: red light is always on when working normally

☐ Error light: when the work is abnormal, the red light will flash

over-temperature

When the head is over-temperature, the error light keeps flashing till it recovers by itself

The error light is always on when lack of paper



Key:

- ☐ In normal mode, press the Move button and the printer feeds paper forward.
- ☐ Self-check mode: install the paper, gently button the upper cover with both hands, press and hold the paper moving button when power is off, then turn on the power switch, release the paper moving button in less than 5 seconds, and the printer will enter the self-check mode and print the self-check list
- ☐ Hexadecimal printing: After the paper is loaded, press the "Go Paper" button and turn on the power. After about 5 seconds, only the power light will be on, release the button, and the printing mode will enter the hexadecimal prompt message and print the data received by the interface with hexadecimal mode.
- ☐ Paper bin opening key: press the paper bin opening key in the direction of the head closing button as shown in Figure 2-2.2 to open the paper bin.

Figure 2-2.2 Paper bin opening key

2.4 The installation of the paper



Thermal paper installation steps:

- ☐ Use the thumb of the right hand to pull the printer's lid opening key upward to open the top cover, as shown in figure 2-3.1.
- ☐ Load the paper roll into the paper bin in the direction shown in the figure, then pull out a piece of paper along the bin and put it flat on the machine head, as shown in figure 2-3.2.
- ☐ Put down the paper cover and gently close the upper cover downward, as shown in figure 2-3.3; Return to the original card position, and the paper emerges from the paper mouth, that is, the printing paper is installed, as shown in figure 2-3.4.



Fig 2-3.1 open



Fig 2-3.2 feed



Fig 2-3.3 close



Fig 2-3.4 finish

2.5 Interface connection

2.5.1 Serial interface connection

The serial interface of ATP2 printer is compatible with RS232C standard and supports RTS/CTS. Its interface socket is 25PIN hole D socket.

Definition of the pin signal

pin	signal	signal source	note
3	RXD	the host	printer receives data
4	RTS	printer	printer can receive data
7	GND	-----	logical
2	TXD	printer	printer sends data

Printer default serial interface settings:

Baud rate: 4800bps (default)

Data bits: 8

Check: none (default)

Stop bit: 1 (default) or 2

Handshake: RTS/CTS

You can modify the above through software commands to meet your transport protocol. Please use the following method to modify:

- a. Connect the printer communication wire to the computer, then connect the power supply and start up
- b. Use the serial debugging assistant as shown in Figure 2-5.1 to set up (Software Link <https://www.microsoft.com/en-gb/p/serial-debug-assistant/9nblggh43hdm?activetab=pivot:overviewtab>)

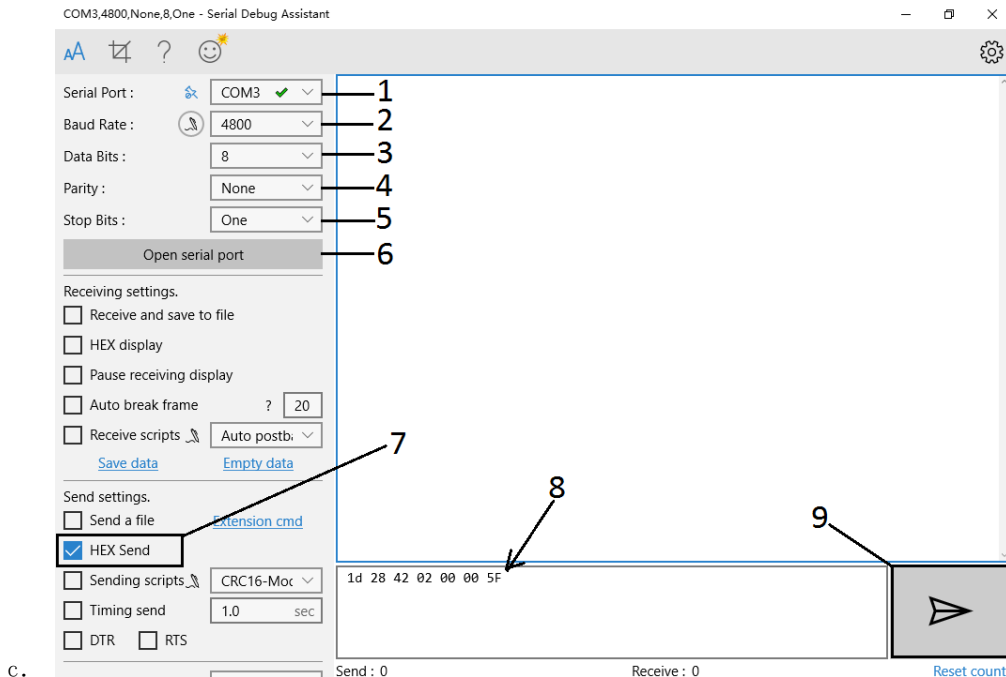

Figure 2-5.1

Follow steps 1-9 as shown in figure 2-5.1.

1. Select the serial port corresponding to the printer
 2. Select the same baud rate as the current printer
 3. Select the data bit consistent with the current printer
 4. Select the parity bit consistent with the current printer
 5. Select the stop bit consistent with the current printer
 6. Click **Open serial port** to open the serial port
 7. Select **HEX Send**
 8. Copy the commands (see Table 2-5.1) needed to set parameters into the command box;
 9. Click **➤**, and wait a few seconds to complete the setup.
- d. The change will take effect after reboot;
 - e. Be sure to record your modified parameter values, otherwise it is likely to affect the communication between PC and printer. Press and hold the "Feed" key first and then turn on the printer switch. The printer will automatically print the modified serial port parameters.
 - f. Make sure your device's communication settings are exactly the same as the printer's, otherwise it will affect or cause the printer not to print properly.

Serial port parameter modification command set

table2-5.1

No.	baud rate	data bits	stop bit	check digit	HEX command code
1	2400	8	1	None	1d 28 42 02 00 00 DF
2	2400	8	1	Even	1d 28 42 02 00 00 DD
3	2400	8	1	Odd	1d 28 42 02 00 00 DB
4	2400	8	2	None	1d 28 42 02 00 00 DE
5	2400	8	2	Even	1d 28 42 02 00 00 DC
6	2400	8	2	Odd	1d 28 42 02 00 00 DA
7	4800	8	1	None	1d 28 42 02 00 00 5F
8	4800	8	1	Even	1d 28 42 02 00 00 5D
9	4800	8	1	Odd	1d 28 42 02 00 00 5B
10	4800	8	2	None	1d 28 42 02 00 00 5E
11	4800	8	2	Even	1d 28 42 02 00 00 5C
12	4800	8	2	Odd	1d 28 42 02 00 00 5A
13	9600	8	1	None	1d 28 42 02 00 00 9F
14	9600	8	1	Even	1d 28 42 02 00 00 9D
15	9600	8	1	Odd	1d 28 42 02 00 00 9B
16	9600	8	2	None	1d 28 42 02 00 00 9E
17	9600	8	2	Even	1d 28 42 02 00 00 9C
18	9600	8	2	Odd	1d 28 42 02 00 00 9A
19	38400	8	1	None	1d 28 42 02 00 00 1F
20	38400	8	1	Even	1d 28 42 02 00 00 1D
21	38400	8	1	Odd	1d 28 42 02 00 00 1B
22	38400	8	2	None	1d 28 42 02 00 00 1E
23	38400	8	2	Even	1d 28 42 02 00 00 1C
24	38400	8	2	Odd	1d 28 42 02 00 00 1A
26	2400	7	1	Even	1d 28 42 02 00 00 FD
27	2400	7	1	Odd	1d 28 42 02 00 00 FB
29	2400	7	2	Even	1d 28 42 02 00 00 FC
30	2400	7	2	Odd	1d 28 42 02 00 00 FA
32	4800	7	1	Even	1d 28 42 02 00 00 7D
33	4800	7	1	Odd	1d 28 42 02 00 00 7B
35	4800	7	2	Even	1d 28 42 02 00 00 7C
36	4800	7	2	Odd	1d 28 42 02 00 00 7A
38	9600	7	1	Even	1d 28 42 02 00 00 BD
39	9600	7	1	Odd	1d 28 42 02 00 00 BB
41	9600	7	2	Even	1d 28 42 02 00 00 BC
42	9600	7	2	Odd	1d 28 42 02 00 00 BA
44	38400	7	1	Even	1d 28 42 02 00 00 3D
45	38400	7	1	Odd	1d 28 42 02 00 00 3B
47	38400	7	2	Even	1d 28 42 02 00 00 3C
48	38400	7	2	Odd	1d 28 42 02 00 00 3A

The serial interface of the ATP2 printer can be connected with the standard RS-232C interface. When connecting with PC, connect according to figure 2-4.1.

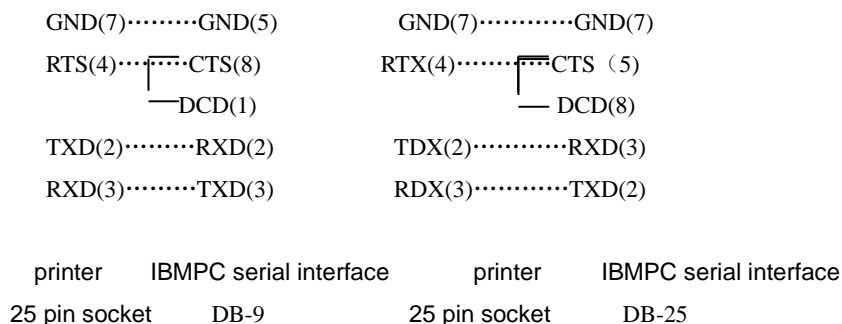

figure 2-4.1. Diagram of connection between printer serial interface and PC serial port

2.5.2 Parallel interface connection

The parallel interface of ATP2 printer is 8-bit printing parallel interface, supports BUSY handshake protocol, and its interface socket is DB25 pin socket.

Parallel interface pin signals

pin	signal	signal source	description
1	nStrobe	H	Data gating triggers pulse. The data is read when the falling edge occurs
2	DATA1	H	0---7 are data bits
3	DATA2	H	
4	DATA3	H	
5	DATA4	H	
6	DATA5	H	
7	DATA6	H	
8	DATA7	H	
9	DATA8	H	
10	nACK	P	Pull the resistance up to the "high" level
11	BUSY	P	"high" level indicates that the printer is "busy" and cannot receive data
12	PE	P	"high" level indicates that the printing paper is exhausted
13	SEL	P	The resistor pulls the "high" level
15	nERR	P	The resistor pulls the "high" level
14、 16、 17	NC		Not connect
18--25	GND		grounded

H= computer, P= printer

Timing sequence of interface signals related to parallel connection mode is shown in figure 2-4.2

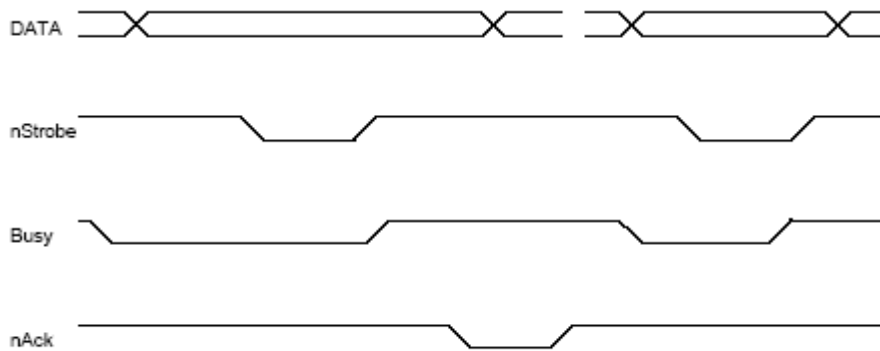

figure 2-4.2. Parallel interface signal timing

2.5.3 Cashbox interface

The cashbox interface of ATP2 printer adopts RJ-11 6-wire socket, as shown in Fig. 2-4.3:



Fig 2-4.3. cashbox interface

Pins are defined as follows:

Pin number	signal	flow
1	The structure	---
2	Cash box drive signal	output
3	Cash box open/close status signal	input
4	Cash box driving power :DC12V	output
5	N.C.	---
6	Cash box open/close status signal ground	---

2.6 The head clean

When the printer has been used for a period of time, it should be cleaned when the printouts are not clear.

☐ Ensure that the power supply is turned off and the power and communication cables are unplugged before cleaning the print head.

☐ Open the top cover of the printer, take out the printing paper, dip the absorbent cotton into a little alcohol, and gently wipe the dirt on the surface of the heating component of the head.

☐ After cleaning, and the alcohol on the head is completely evaporated, then put on the paper and close the lid. Power on with self-test, observe the cleaning effect.

Chapter 3 Troubleshooting

fault	solution
No power	Check the power adapter for voltage output.
	Check whether the power output plug is properly connected to the printer.
	Check whether the power switch of the printer is on.
Not feed	Check whether the printer rolls are used up.
	Check whether the paper roll of the printer is stuck.
	Check the printer to see if the paper switch is dirty.
	Check whether the paper pressing wheel on the cover of the printer is pressed in place.
Print not clear	Check whether the printer head is too dirty.
	Check whether the printing paper is damp.
Don't print	Check whether the interface wire between the printer and PC is properly connected.

3.1 Command

command	note
LF	Print and line feed
ESC J n	Print and feed N points on the line
ESC 2	Set character line spacing to 1/6 inch
ESC 3 n	Set the row spacing to n points (n/203 inches)
ESC ! n	Sets how characters are printed
ESC SO	Allow multiple character width printing
ESC DC4	Cancel character doubling printing
ESC % n	Allow/disable user - defined characters
ESC & s n m	Set user - defined characters
ESC c 5 n	Allow/disable key on/off commands
GS w n	Set bar code width
GS h n	Set bar code height
GS k m d1 ... dk NUL ② GS k m n d1... dn	Print barcode
ESC @	Printer initialization
ESC p m n1 n2	Cashbox control

3.2 Print command

3.2.1 Print command

LF

Print and line feed

format	ASCII : LF
	decimalism : 10
	hexadecimal : 0A
description	Print the contents of the line buffer and moves one line forward, only one line forward when the line buffer is empty

ESC J n

Print and feed N points on the line

format	ASCII: ESC J n
	decimalism: 27 74 n
	hexadecimal: 1B 4A n
description	Print out the contents of the line buffer and move the paper forward N points of line (i.e. N /203 inches), N =0 ~ 255
	This command only works on the line and does not change the line spacing set by the ESC 2, ESC 3 commands

3.2.2 Line spacing set command

ESC 2

Set character line spacing to 1/6 inch

format	ASCII: ESC 2
	decimalism: 27 50
	hexadecimal: 1B 32
description	Set the line spacing to 1/6 inch

ESC 3 n

Set the row spacing to n points (n/203 inches)

format	ASCII: ESC 3 n
	decimalism: 27 51 n
	hexadecimal: 1B 33 n
description	Sets the row spacing to n points.N = 0 ~ 255
	The ATP2 printer has a dot spacing of 1/203 ", that is, this command sets the line spacing to N /203 ". The default value is n=30

3.2.3 Character print command

ESC ! n

Sets how characters are printed

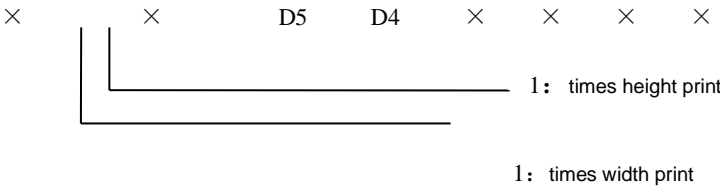
format	ASCII: ESC ! n
	decimalism: 27 33 n
	hexadecimal: 1B 21 n
description	Sets the row spacing to n points.N = 0 ~ 255
	<p>ESC ! N is a comprehensive character printing mode setting command that selects the size of the printed character. The default value of n is 0, which means that characters are not amplified. Each of the print parameters n is defined as follows:</p> 

ESC S0

Allows multiple character width printing

format	SCII: ESC S0
	decimalism: 27 14
	hexadecimal: 1B 0E
description	All characters on a line following the command are printed at twice of the normal width
	This command can be deleted with carriage enter or the DC4 command

ESC DC4

Cancel character width printing

format	ASCII: ESC DC4
	decimalism: 27 20
	hexadecimal: 1B 14
description	After executing this command, character printing resumes at normal width

ESC % n

Allow/disable user - defined characters

format	ASCII : ESC % n
	decimalism : 27 37 n
	hexadecimal : 1B 25 n
description	When n=1, select the user-defined character set; When n=0, select the internal character set
	The default value of n = 0

ESC & s n m

Set user - defined characters

format	ASCII : ESC & S n m [a[p]s×a]m-n+1
	decimalism : 27 38 S n m [a[p]s×a]m-n+1
	hexadecimal : 1B 26 S n m [a[p]s×a]m-n+1
description	ESC & is used to define user-defined characters. S = 3 32≤n≤m≤126 0≤a≤12,0≤p≤255

	S is the number of vertical bytes, where s=3;N is the starting ASC II code for the custom character
	M represents the termination ASC II code for custom characters. When only one character is defined, N = M is used, and up to 96 custom characters can be defined
	A is the number of points in the horizontal direction; P represents the data of custom characters, each character is S x A bytes, a total of M-N +1 characters are defined.
	Custom characters remain valid after definition until they are redefined or reset or shut down.

3.2.4 Special control command

ESC c 5 n

Allow/disable key on/off commands

format	ASCII: ESC c 5 n
	decimalism: 27 99 53 n
	hexadecimal: 1B 63 35 n
description	N =1, disable paper feed key;
	The feed key is enabled when n=0. The default value is n=0

3.2.5 Bar code command

GS w n

Set bar code width

format	ASCII : GS w n						
	Hexadecimal code : 1D 77 n						
	decimalism code : 29 119 n						
description	<ul style="list-style-type: none"> ☐ Set the bar code horizontal size, $2 \leq n \leq 3$ ☐ N sets bar code width as follows: <table border="1" style="margin-left: 20px;"> <tr> <td>N</td> <td>bar code</td> </tr> <tr> <td>2</td> <td>normal</td> </tr> <tr> <td>3</td> <td>wide bar code</td> </tr> </table> 	N	bar code	2	normal	3	wide bar code
	N	bar code					
2	normal						
3	wide bar code						
<ul style="list-style-type: none"> ☐ The following barcode systems are supported: CODE128, CODE39, ITF The default value is n=2 Associated command: GS K 							

GS h n

Set Barcode height

format	ASCII : GS h n
	Hexadecimal code : 1D 68 n
	decimalism code : 29 104 n
description	<ul style="list-style-type: none"> ☐ Set bar code height, $1 \leq n \leq 255$; ☐ N sets the number of points in the vertical direction; ☐ The default value $n=50$ ☐ Associated command: GS K

① GS k m dl ... dk NUL ② GS k m n dl ... dn

Print Barcode

format	① ASCII code : GS k m dl ... dk NUL																	
	Hexadecimal code: 1D 6B m dl ... dk 00																	
	decimalism code : 29 107 m dl ... dk 0																	
	② ASCII code : GS k m n dl .. dn																	
	Hexadecimal code: 1D 6B m n dl .. dn																	
	decimalism code : 29 107 m n dl .. dn																	
description	☐ Select the barcode system and print the barcode;																	
	① $4 \leq m \leq 5$ (k and d depend on the barcode system used)																	
	② $m=73$ (n and d depend on the barcode system used)																	
	☐ M selects barcode system is as follows:																	
	<table border="1" style="width: 100%; border-collapse: collapse;"> <thead> <tr> <th style="width: 5%;">M</th> <th style="width: 10%;">barcode system</th> <th style="width: 25%;">the number of characters</th> <th style="width: 60%;">note</th> </tr> </thead> <tbody> <tr> <td rowspan="2">①</td> <td>4</td> <td>CODE39</td> <td>$1 \leq K$ $48 \leq d \leq 57, 65 \leq d \leq 90, 32, 36, 37, 43, 45, 46, 47$</td> </tr> <tr> <td>5</td> <td>ITF</td> <td>$1 \leq K$ (k is even) $48 \leq d \leq 57$</td> </tr> <tr> <td>②</td> <td>73</td> <td>CODE128</td> <td>$1 \leq n \leq 255$ $0 \leq d \leq 127$</td> </tr> </tbody> </table>				M	barcode system	the number of characters	note	①	4	CODE39	$1 \leq K$ $48 \leq d \leq 57, 65 \leq d \leq 90, 32, 36, 37, 43, 45, 46, 47$	5	ITF	$1 \leq K$ (k is even) $48 \leq d \leq 57$	②	73	CODE128
M	barcode system	the number of characters	note															
①	4	CODE39	$1 \leq K$ $48 \leq d \leq 57, 65 \leq d \leq 90, 32, 36, 37, 43, 45, 46, 47$															
	5	ITF	$1 \leq K$ (k is even) $48 \leq d \leq 57$															
②	73	CODE128	$1 \leq n \leq 255$ $0 \leq d \leq 127$															
<p>【note①】</p> <ul style="list-style-type: none"> • The command is terminated by a NUL code. • The number of ITF barcode data must be an even number. When an odd number is entered, the printer ignores the last data received. <p>【note②】</p> <ul style="list-style-type: none"> • N specifies the number of bytes of barcode data, and the printer 																		

processes N bytes of data as barcode data starting with the next character.

- If n goes beyond the specified range, the printer stops processing the command and processes the subsequent data as normal data.
- This command feeds the paper as required to print the barcode, regardless of the line spacing set by ESC 2 or ESC 3.
- This command is valid only if there is no data in the print buffer. When there is data in the print buffer, the printer processes m's subsequent data as ordinary data.
- After printing the barcode, this command sets the printing position to the beginning of the line.
- This command is not affected by the print mode (character size, etc.), except by reversing the print mode.

When using CODE128 (m=73) :

- For information on the CODE128 barcode and its coding table, see Appendix I.
- When using CODE128 for this printer, please consider the following data transfer factors:
 - ① The header of the barcode data string must be the CODE set selection character (Code A, Code B, or Code C), which is used to select the CODE set to be used first.
 - ② Use the word "{" and a character to define a special character. Define the ASCII character '{' by passing two '{' consecutively.

Special characters	transmit data		
	ASCII code	hexadecimal	decimalism
SHIFT	{S	7B,53	123,83
CODE A	{A	7B,41	123,65
CODE B	{B	7B,42	123,66
CODE C	{C	7B,43	123,67
FNC1	{1	7B,31	123,49
FNC2	{2	7B,32	123,50
FNC3	{3	7B,33	123,51
FNC4	{4	7B,34	123,52
"{"	{{	7B,7B	123,123

- If the barcode's data string header is not a code set selection character, the printer stops command processing and processes subsequent data as ordinary data.
- If the combination of '{' and subsequent characters does not apply to any special characters, the printer stops command processing and processes the subsequent data as ordinary data.

	<ul style="list-style-type: none"> • If the printer receives a character that cannot be used for a special encoding set, the printer stops command processing and processes the subsequent data as ordinary data.
--	--

3.2.6 Other commands

ESC @

Printer initialization

format	ASCII : ESC @
	decimalism : 27 64
	hexadecimal : 1B 40
description	<p>ESC @ The command initializes the printer with the following:</p> <ul style="list-style-type: none"> ☐ Clear the print buffer; ☐ Restore default values; ☐ Select the character printing method; ☐ Delete user-defined characters.

ESC p m n1 n2

Cashbox control

format	ASCII : ESC p m n1 n2
	decimalism : 27 112 m n1 n2
	hexadecimal : 1B 70 m n1 n2
description	<p>This command is used to generate pulses at regular intervals according to n1, n2 to control the action of the cash box</p> <p>m=0, 0<n1≤n2≤255</p> <p>The opening time is n1×2ms, and the closing time is n2×2ms</p>

Appendix 1: CODE128 barcode

1. CODE128 barcode description

In the CODE128 barcode system, a barcode character set can represent up to 128 ASCII characters and 2-bits. These barcode characters are defined by 103 barcode characters and 3 code sets. Each code set represents the following characters:

- code set A : ASCII character 00H to 5FH
- code set B: ASCII character 20H to 7FH
- code set C: 2-bit natural numeric characters represented by one character (100 digits from 00 to 99)

There are also the following special characters in CODE128:

- SHIFT character

Code following SHIFT in code set A is treated as character in code set B. Code following SHIFT in code set B is

treated as character in code set A. The SHIFT character cannot be used in code set C.

- Code set selection character (CODE A, CODE B, CODE C)

This character converts subsequent code sets to code sets A, B, or C

- Function character (FNC1, FNC2, FNC3, FNC4)

The use of functional characters depends on the application. In code set C, only FNC1 is available.

2、 Code table

Printable characters in code set A

character	transmit data		character	transmit data		character	transmit data	
	hexadecimal	decimal		hexadecimal	decimal		hexadecimal	decimal
NUL	00	0	(28	40	P	50	80
SOH	01	1)	29	41	Q	51	81
STX	02	2	*	2A	42	R	52	82
ETX	03	3	+	2B	43	S	53	83
EOT	04	4	,	2C	44	T	54	84
ENQ	05	5	-	2D	45	U	55	85
ACK	06	6	.	2E	46	V	56	86
BEL	07	7	/	2F	47	W	57	87
BS	08	8	0	30	48	X	58	88
T	09	9	1	31	49	Y	59	89
LF	0A	10	2	32	50	Z	5A	90
VT	0B	11	3	33	51	[5B	91
FF	0C	12	4	34	52	\	5C	92
CR	0D	13	5	35	53]	5D	93
SO	0E	14	6	36	54	^	5E	94
SI	0F	15	7	37	55	_	5F	95
DLE	10	16	8	38	56	FNC1	7B, 31	123,49
DC1	11	17	9	39	57	FNC2	7B,32	123,50
DC2	12	18	:	3A	58	FNC3	7B,33	123,51
DC3	13	19	;	3B	59	FNC4	7B,34	123,52
DC4	14	20	<	3C	60	SHIFT	7B,53	123,83
NAK	15	21	=	3D	61	CODEB	7B,42	123,66
SYN	16	22	>	3E	62	CODEC	7B,43	123,67
ETB	17	23	?	3F	63			
CAN	18	24	@	40	64			
EM	19	25	A	41	65			
SUB	1A	26	B	42	66			
ESC	1B	27	C	43	67			
FS	1C	28	D	44	68			
GS	1D	29	E	45	69			
RS	1E	30	F	46	70			
US	1F	31	G	47	71			
SP	20	32	H	48	72			

!	21	33	I	49	73			
"	22	34	J	4A	74			
#	23	35	K	4B	75			
\$	24	36	L	4C	76			
%	25	37	M	4D	77			
&	26	38	N	4E	78			
'	27	39	O	4F	79			

Printable characters in code set B

character	transmit data		character	transmit data		character	transmit data	
	hexadecimal	decimal		hexadecimal	decimal		hexadecimal	decimal
SP	20	32	H	48	72	p	70	112
!	21	33	I	49	73	q	71	113
"	22	34	J	4A	74	r	72	114
#	23	35	K	4B	75	s	73	115
\$	24	36	L	4C	76	t	74	116
%	25	37	M	4D	77	u	75	117
&	26	38	N	4E	78	v	76	118
'	27	39	O	4F	79	w	77	119
(28	40	P	50	80	x	78	120
)	29	41	Q	51	81	y	79	121
*	2A	42	R	52	82	z	7A	122
+	2B	43	S	53	83	{	7B,7B	123,123
,	2C	44	T	54	84		7C	124
-	2D	45	U	55	85	}	7D	125
.	2E	46	V	56	86	—	7E	126
/	2F	47	W	57	87	DEL	7F	127
0	30	48	X	58	88	FNC1	7B,31	123,49
1	31	49	Y	59	89	FNC2	7B,32	123,50
2	32	50	Z	5A	90	FNC3	7B,33	123,51
3	33	51	[5B	91	FNC4	7B,34	123,52
4	34	52	\	5C	92	SHIFT	7B,53	123,83
5	35	53]	5D	93	CODEA	7B,41	123,66
6	36	54	^	5E	94	CODEC	7B,43	123,67
7	37	55	_	5F	95			
8	38	56	`	60	96			
9	39	57	a	61	97			
:	3A	58	b	62	98			
;	3B	59	c	63	99			
<	3C	60	d	64	100			
=	3D	61	e	65	101			
>	3E	62	f	66	102			

?	3F	63	g	67	103			
@	40	64	h	68	104			
A	41	65	i	69	105			
B	42	66	j	6A	106			
C	43	67	k	6B	107			
D	44	68	l	6C	108			
E	45	69	m	6D	109			
F	46	70	n	6E	110			
G	47	71	o	6F	111			

Printable characters in code set C

character	transmit data		character	transmit data		character	transmit data	
	hexadecimal	decimal		hexadecimal	decimal		hexadecimal	decimal
00	00	0	40	28	40	80	50	80
01	01	1	41	29	41	81	51	81
02	02	2	42	2A	42	82	52	82
03	03	3	43	2B	43	83	53	83
04	04	4	44	2C	44	84	54	84
05	05	5	45	2D	45	85	55	85
06	06	6	46	2E	46	86	56	86
07	07	7	47	2F	47	87	57	87
08	08	8	48	30	48	88	58	88
09	09	9	49	31	49	89	59	89
10	0A	10	50	32	50	90	5A	90
11	0B	11	51	33	51	91	5B	91
12	0C	12	52	34	52	92	5C	92
13	0D	13	53	35	53	93	5D	93
14	0E	14	54	36	54	94	5E	94
15	0F	15	55	37	55	95	5F	95
16	10	16	56	38	56	96	60	96
17	11	17	57	39	57	97	61	97
18	12	18	58	3A	58	98	62	98
19	13	19	59	3B	59	99	63	99
20	14	20	60	3C	60	FNC1	7B,31	123,49
21	15	21	61	3D	61	CODEA	7B,41	123,65
22	16	22	62	3E	62	CODEB	7B,42	123,66
23	17	23	63	3F	63			
24	18	24	64	40	64			
25	19	25	65	41	65			
26	1A	26	66	42	66			
27	1B	27	67	43	67			

28	1C	28	68	44	68			
29	1D	29	69	45	69			
30	1E	30	70	46	70			
31	1F	31	71	47	71			
32	20	32	72	48	72			
33	21	33	73	49	73			
34	22	34	74	4A	74			
35	23	35	75	4B	75			
36	24	36	76	4C	76			
37	25	37	77	4D	77			
38	26	38	78	4E	78			
39	27	39	79	4F	79			

4. PRINTER INSTALLATION AND OPERATION

4.1 *Packing List*

Item	Part Number	Quantity
Adam Thermal Printer 2	1.12.0.0.15779	1
Power Adaptor Module	3.12.4.0.11269	1
Mains cable	Country dependant	1
RS 232 Convertible joint ,DB9-male	3.12.4.0.14662	1
AIP RS 232 cable male,DB9-hole type	3.12.4.0.14663	1
Thermal paper 58mm	3.12.6.0.11263	1
CD Manual	3.01.0.0.14085	1

WARRANTY STATEMENT

Adam Equipment offers Limited Warranty (Parts and Labour) for any components that fail due to defects in materials or workmanship. Warranty starts from the date of delivery.

During the warranty period, should any repairs be necessary, the purchaser must inform its supplier or Adam Equipment Company. The company or its authorised Technician reserves the right to repair or replace the components at any of its workshops at no additional cost, depending on the severity of the problems. However, any freight involved in sending the faulty units or parts to the Service Centre should be borne by the purchaser.

The warranty will cease to operate if the equipment is not returned in the original packaging and with correct documentation for a claim to be processed. All claims are at the sole discretion of Adam Equipment.

This warranty does not cover equipment where defects or poor performance is due to misuse, accidental damage, exposure to radioactive or corrosive materials, negligence, faulty installation, unauthorised modifications or attempted repair, or failure to observe the requirements and recommendations as given in this User Manual.

This product may include a rechargeable battery that is designed to be removed and replaced by the user. Adam Equipment warrants that it will provide a replacement battery if the battery manifests a defect in materials or workmanship during the initial period of use of the product in which the battery is installed.

As with all batteries, the maximum capacity of any battery included in the product will decrease with time or use, and battery cycle life will vary depending on product model, configuration, features, use, and power management settings. A decrease in maximum battery capacity or battery cycle life is not a defect in materials or workmanship, and is not covered by this Limited Warranty.

Repairs carried out under the warranty do not extend the warranty period. Components removed during warranty repairs become company property.

The statutory rights of the purchaser are not affected by this warranty. The terms of this warranty is governed by the UK law. For complete details on Warranty Information, see the terms and conditions of sale available on our web-site.

WEEE 2012/19/EU

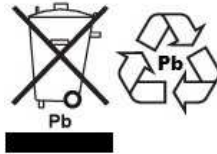

This device may not be disposed of in domestic waste. This also applies to countries outside the EU, per their specific requirements. Disposal of batteries (if fitted) must conform to local laws and restrictions.

Cet appareil ne peut être éliminé avec les déchets ménagers. L'élimination de la batterie doit être effectuée conformément aux lois et restrictions locales.

Dieses Gerät nicht mit dem Hausmüll entsorgt.

Dispositivo no puede ser desechado junto con los residuos domésticos

Dispositivo non può essere smaltito nei rifiuti domestici.

FCC / IC CLASS A DIGITAL DEVICE EMC VERIFICATION STATEMENT

NOTE: This equipment has been tested and found to comply with the limits for a Class A digital device, pursuant to Part 15 of the FCC rules and Canadian ICES-003/NMB-003 regulation. These limits are designed to provide reasonable protection against harmful interference when the equipment is operated in a commercial environment. This equipment generates, uses and can radiate radio frequency energy and, if not installed and used in accordance with the instruction manual, may cause harmful interference to radio communications. Operation of this equipment in a residential area is likely to cause harmful interference in which case the user will be required to correct the interference at his own expense.

CALIFORNIA PROPOSITION 65 - MANDATORY STATEMENT

WARNING: This product includes a sealed lead-acid battery which contains chemicals known to the State of California to cause cancer and birth defects or other reproductive harm.



Adam Equipment products have been tested with, and are always supplied with mains power adaptors which meet all legal requirements for the intended country or region of operation, including electrical safety, interference and energy efficiency. As we often update adaptor products to meet changing legislation it is not possible to refer to the exact model in this manual. Please contact us if you need specifications or safety information for your particular item. Do not attempt to connect or use an adaptor not supplied by us.

ADAM EQUIPMENT is an ISO 9001:2015 certified global company with more than 50 years' experience in the production and sale of electronic weighing equipment.

Adam products are predominantly designed for the Laboratory, Educational, Health and Fitness, Retail and Industrial Segments. The product range can be described as follows:

- Analytical and Precision Laboratory Balances
- Compact and Portable Balances
- High Capacity Balances
- Moisture analysers / balances
- Mechanical Scales
- Counting Scales
- Digital Weighing/Check-weighing Scales
- High performance Platform Scales
- Crane scales
- Mechanical and Digital Electronic Health and Fitness Scales
- Retail Scales for Price computing

For a complete listing of all Adam products visit our website at

www.adamequipment.com

<p>Adam Equipment Co. Ltd. Maidstone Road, Kingston Milton Keynes MK10 0BD UK Phone:+44 (0)1908 274545 e-mail: sales@adamequipment.co.uk</p>	<p>Adam Equipment Inc. 1, Fox Hollow Rd. Oxford, CT 06478 USA Phone: +1 203 790 4774 e-mail: sales@adamequipment.com</p>	<p>AE Adam GmbH. Instenkamp 4 D-24242 Felde Germany Phone +49 (0)4340 40300 0 e-mail: vertrieb@aeadam.de</p>
<p>Adam Equipment S.A. (Pty) Ltd. 7 Megawatt Road, Spartan EXT 22 Kempton Park, Johannesburg, Republic of South Africa Phone +27 (0)11 974 9745 e-mail: sales@adamequipment.co.za</p>	<p>Adam Equipment (S.E. ASIA) PTY Ltd 70 Miguel Road Bibra Lake Perth WA 6163 Australia Phone: +61 (0) 8 6461 6236 e-mail: sales@adamequipment.com.au</p>	<p>Adam Equipment (Wuhan) Co. Ltd. Building E, East Area, Private Industrial Park, Wuhan EDZ, Hubei Province , P.R.China Phone: + 86 (27) 59420391 e-mail: info@adamequipment.com.cn</p>

© Copyright by Adam Equipment Co. All rights reserved. No part of this publication may be reprinted or translated in any form or by any means without the prior permission of Adam Equipment. Adam Equipment reserves the right to make changes to the technology, features, specifications and design of the equipment without notice. All information contained within this publication is to the best of our knowledge timely, complete and accurate when issued. However, we are not responsible for misinterpretations which may result from the reading of this material. The latest version of this publication can be found on our Website. www.adamequipment.co.uk