

BioCLAVE™

Operations Manual For Research Use Only

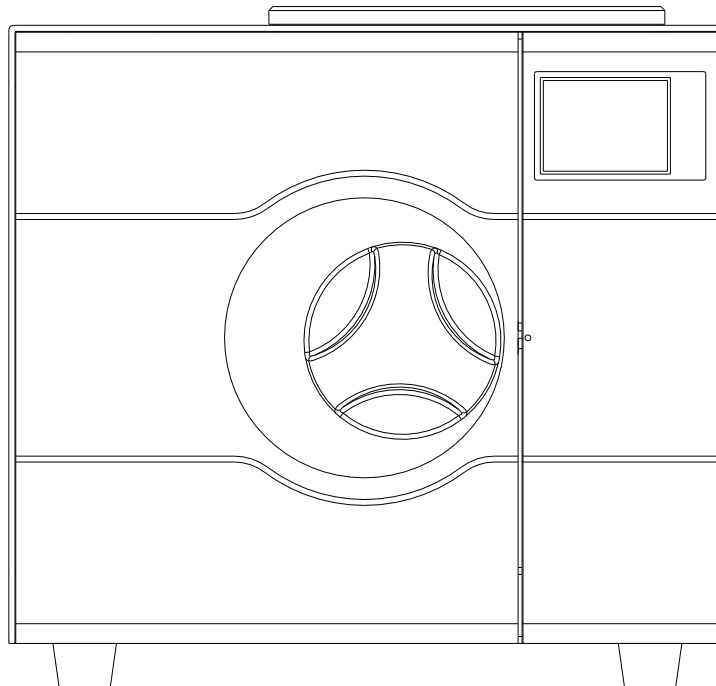

Benchmark 
Scientific

PH: 908-769-5555 EM: info@BenchmarkScientific.com
WEB: www.BenchmarkScientific.com

Thank you for choosing the BioClave Benchtop Sterilizer.

Prior to operating this instrument, please read the operations manual carefully and follow all installation instructions.

TABLE OF CONTENTS

1. GENERAL	1
2. TECHNICAL SPECIFICATIONS	2
3. PACKING CONTENT	2
4. INSTALLATION	3
5. OPERATION	3
5.1 SETUP	3
5.2 PREPARATION OF STERILIZATION MATERIALS	4
5.3 SELECTING THE STERILIZATION PROGRAM	4
5.4 RUNNING THE STERILIZATION PROGRAM	5
6. ADVANCED SETTINGS	6
7. MAINTENANCE	9
8. TRANSPORTATION AND STORAGE	11
9. ERROR CODES	12
10. SAFETY DEVICES	13

APPENDIX

1. WATER PROPERTIES/CHARACTERISTICS	14
2. DIAGRAMS OF THE STERILIZATION PROGRAMS	15
3. WIRING DIAGRAMS	17
4. HYDRAULIC DRAWING	18

1 General

The sterilizer described in this manual is intended for the sterilization of research tools. It operates automatically with 134°C and 121°C sterilization temperatures. This sterilizer is in compliance with the European Directive 93/42/CEE and it has been produced in accordance with the EN 13060. In addition the chamber has been ASME certified.

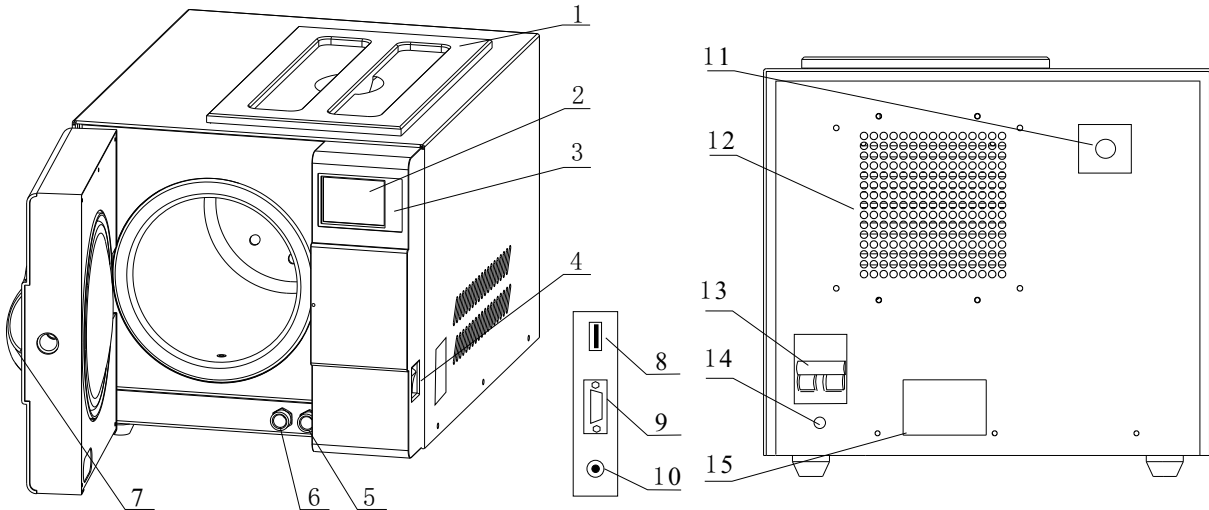

- | | |
|---------------------------------------|--------------------------|
| 1 Distilled water tank | 9 Printer port |
| 2 LED screen | 10 Printer power |
| 3 Control panel | 11 Safety valve |
| 4 Main Power switch | 12 Condenser ventilation |
| 5 Drain valve of distilled water tank | 13 Circuit breaker |
| 6 Drain valve of used water tank | 14 Power supply cord |
| 7 Door handle | 15 Rating plate |
| 8 USB port (optional) | |

Security Notice

For safe operation, please pay close attention to the alert symbols below which can be found throughout this manual. Please carefully read and understand the contents of this manual prior to operating this instrument.



This symbol represents an electrical caution - ground protection



HOT SURFACE.

This symbol represents a warning of a potential hot surface.



Important safety information.

This symbol represents a warning for extra caution

2 Technical Specifications

Item	Parameter
Chamber	Φ170mmX320mm
Rated Voltage	110V-130V or 220V-240V, AC, 50-60Hz
Main Fuses	F25A/250V for 110V or F16A/250V for 220V
Nominal power	1400VA
Sterilization Temperature	250°F/274°F
Capacity of the distilled water tank	Approx 2.5L (water at level MAX)
	Approx 0.5L (water at level MIN)
Operation temperature	41 - 104°F
Exterior Dimensions	445mm(width)X 410mm(height)X 605mm(depth)
Weight	66 lb
Noise Level	<70dB
Relative Humidity	max. 80%, non condensing
Atmospheric pressure	11.0psi-15.4psi

3 Packing Content

No.	Item	Quantity
1	Steam sterilizer	1
2	Instrument tray	2
3	Instrument tray rack	1
4	Instrument tray handle	1
5	Door adjustment tool	1
6	Draining hose	2
7	Instructions manual	1
8	Door seal	1

4 Installation

Ensure that the sterilizer is installed with 2.5in. (10cm) ventilation space on all sides of the sterilizer, and 5 in. (20cm) on top side. The clearance required to open the door is 15.5in. (40cm).

The sterilizer should be placed on a level worktable.

Do not cover or block the door, ventilation or radiation openings on the sterilizer.

Do not install the sterilizer near a sink or in a location where it is likely to be splashed.

Do not install the sterilizer nearby a heat source.

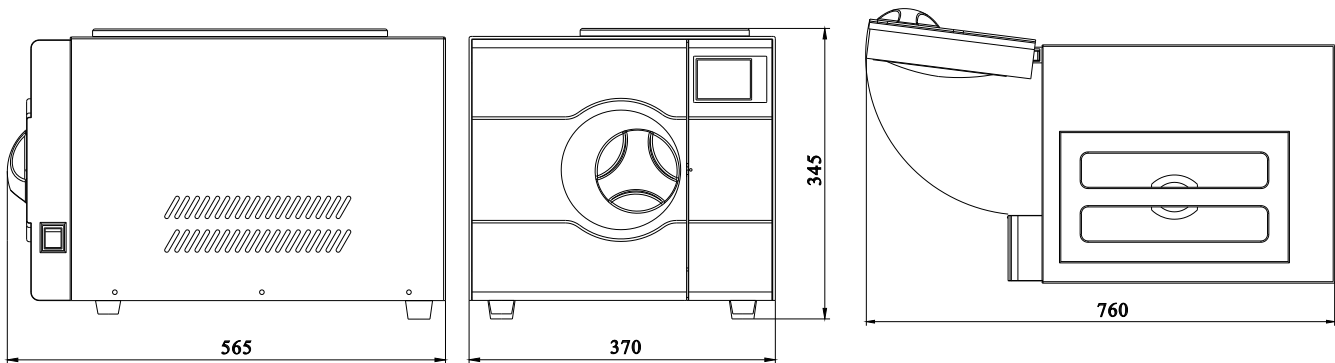

5 Operation

5.1 Setup

5.1.1 Open the door and remove all of the inner contents for unpacking.

5.1.2 Connect the power cord to an outlet of the appropriate voltage

5.1.3 Power on

The switch is located underneath the control panel on the front side of the machine.

After switching on, the machine turns on the LCD and shows the door position, water level, working program, date, time and etc.

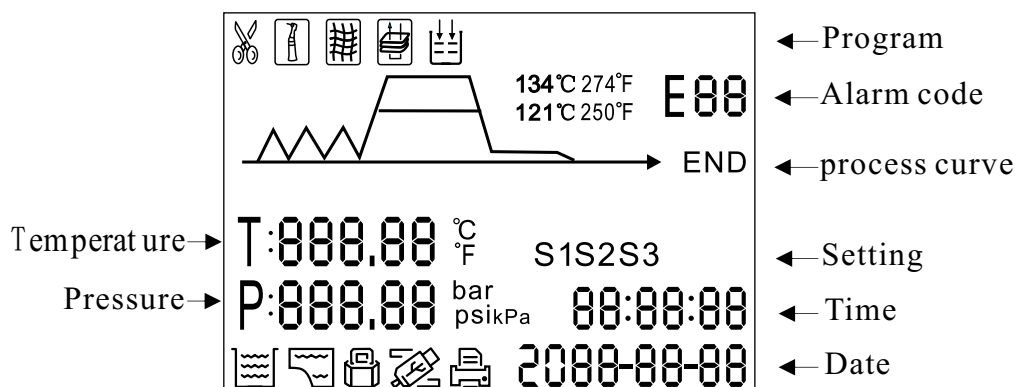
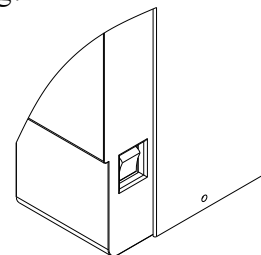

Distilled water tank is requires water.

Distilled water tank is full

Used water tank is full.

Door locked

information output to USB port

Printer is connected

Notice: Before using the sterilizer or at any time the low water icon  blinks, it is necessary to fill the distilled water tank with distilled water.

5.1.4 Filling the distilled water

Remove the cover, and fill the tank with distilled water.

When you hear a beep signal, it means the water level exceeds the max. level. The  will be displayed. Please stop filling immediately.

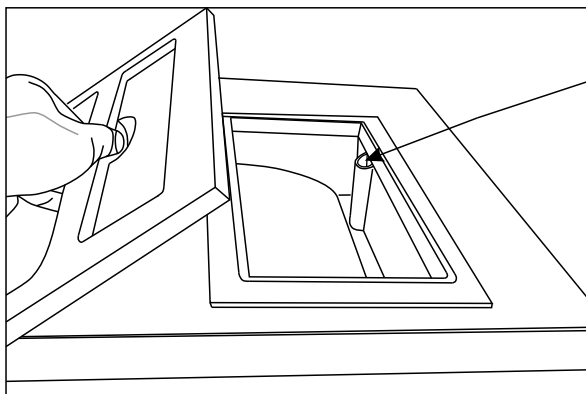

The water level should not exceed this port.

5.2 Preparation of sterilization materials

For the most effective sterilization and to preserve the sample, please follow below:

- * Arrange the samples of different material on different trays or with at least 2in. of space between them.
- * Always insert a sterilization paper or cloth between the tray and sample, to avoid direct contact between the different materials.

5.3 Selecting the sterilization program

5.3.1 LCD

The panel displays the cycle temperature, pressure, error code, sterilization state and program.





5.3.2  Temperature button
Press this button to toggle between 121°C and 134°C

5.3.3  Program button
Press this button to toggle between available sterilization cycles (see below)

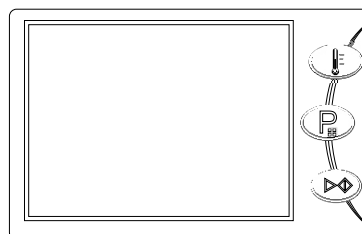
5.3.4  START/STOP button

Press this button to start the sterilization cycle. To stop a cycle, press and hold this button for 3 seconds.



-  UNWRAPPED (SOLID)
-  WRAPPED
-  DRYING
-  EXTENSIVE (PRION)
-  LIQUID

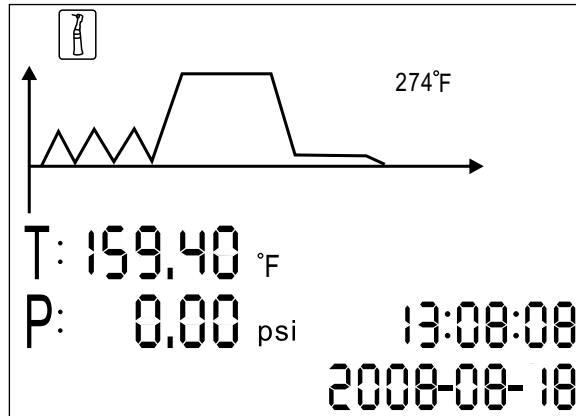

Notice: Button will be “locked” for the initial 10 seconds after power up for system initialization.

5.4 Running the sterilization program.

After selecting program, the materials to be sterilized can now be placed on the tray and the tray placed inside the chamber using the tray

5.4.1 After the instruments are loaded, you may close and lock the door by turning the door  handle clockwise until it stops.

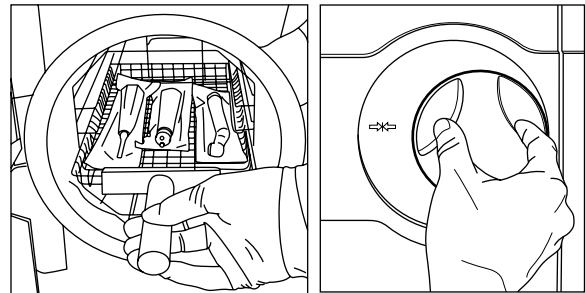

Caution: You must turn the door handle to the maximum position, otherwise the machine will alarm and prevent completing the cycle.

5.4.2 Start the sterilization program.

Press START button, the machine will begin the cycle automatically. It will take 30-75 minutes. (See Appendix 2)

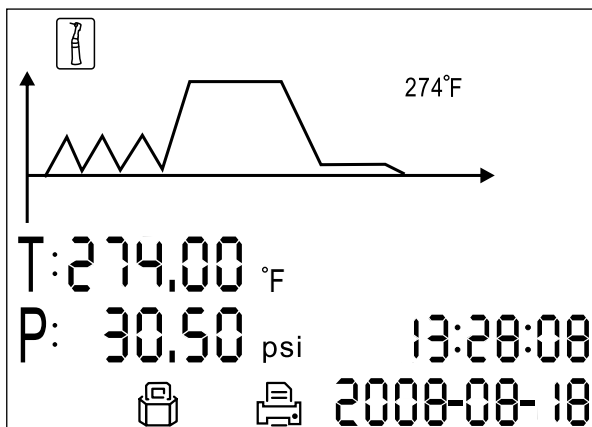

total time or count down until completion ←

Caution: When you press the START button but the door has not been fully closed. You will see the  blinking on the screen. A cycle can not be started until you close the door to the max. position and press the "Start" button again.

5.4.3 Sterilization cycle completion

After a cycle is completed, the printer will be activated and print out a report of the cycle settings (if the optional printer has been connected).

After the pressure returns to 0, the door is unlocked and the materials can be

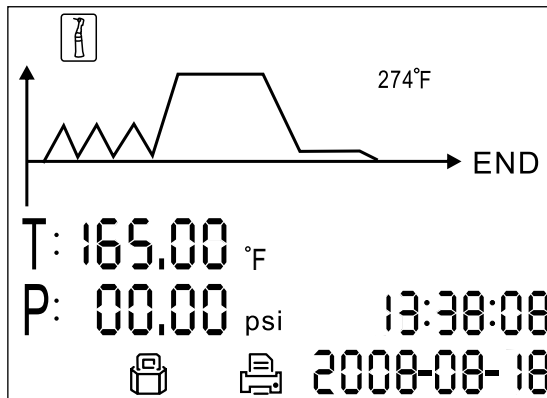

Always use the tray handle to load or unload the tray into the autoclave. Failure to do so can result in burning.

If you need to interrupt a cycle and remove materials urgently, you may hold the START button for 3 seconds after completing sterilization time to skip the dry cycle.

This will result in the program skipping directly to the last step and eliminate the drying stage. After one minute the cycle

6 Advanced Setting

6.1 Enter the setting

6.1.1 Power on the machine while Holding the START button and hold for 5 seconds. This will enter into the advanced settings mode.

6.1.2 Select the state (State 1 thru. 3) by pressing the Program button. Press the START button to enter the setting.

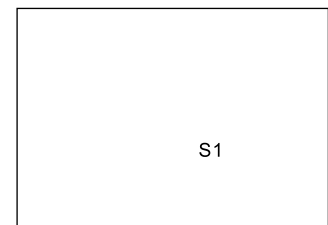

6.2 S1 state

If you select the S1. You may change the unit of temperature and pressure, and adjust time and date.

6.2.1 The first option is to select the unit of temperature. Press temperature button to select °C or °F.

The unit you selected will be lighted. Press the program button to the next item.

6.2.2 You may select the unit of pressure in the same manner.

6.2.3 Then press program button to the next item to adjust the time and date. After the last word of the date or time is set, then the data is permitted to be saved. If you want to finish the setting you shall press START. It will return to the screen of selecting states.

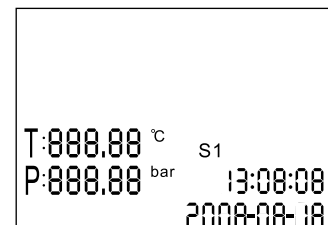

6.3 S2 state

6.3.1 You may check the count of sterilization cycle. It can not be changed by operator.

6.3.2 Set the parameter for high altitude.

If you have trouble completing a cycle in a location of high altitude (above 2.0 km or atmospheric pressure is below 80kPa)

you may need to adjust this parameter.

6.3.3 Language set:

00 English 01 German 02 Spanish 03 Polish
04 French 05 Magyar 06 Romanian 07 Dutch
08 Lithuanian 09 Latvian

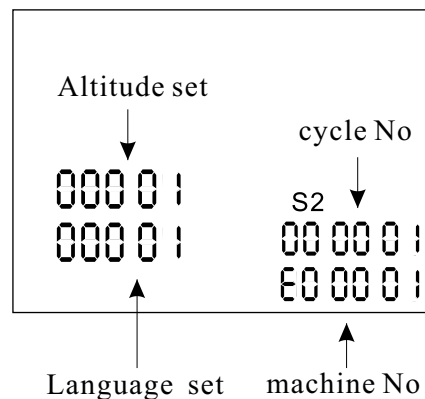

The Machine No. And cycle No can not be set by the operator.

6.4 S3 state

6.4.1 Adjust the length of sterilization and drying time.

Press program button to select the program. ()

Press temperature button to select the temperature of program.

Then press START to adjust the drying time and holding time.

6.4.2 First to adjust the holding time.

Press temperature button to adjust the data.

Press the program button to select the items.

6.4.3 Press START to save .

6.4.4 Drying time is 0-19.

Holding time of 250 °F is 1-59.

Holding time of 274 °F is 1-19.

holding time →
drying time →

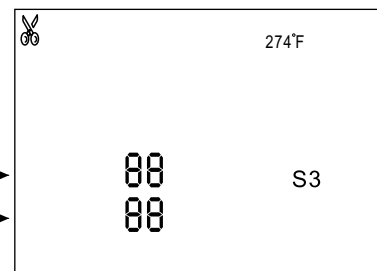

Notice: the default sterilization parameters have been chosen to provide optimal sterilization results. We do not suggest adjusting these parameters unless it is necessary.

6.5 Printer (Optional)

6.5.1 Connect the printer cable.

6.5.2 Connect the printer power.

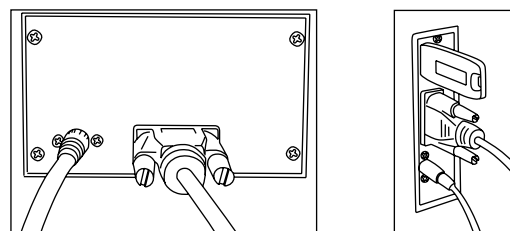

6.6 USB Flash memory (Optional)

A USB drive can be used as a method of storing a report of the cycle. To do so, insert the USB drive to the slot on the right side of the instrument.

The information will automatically output directly to the USB after the cycle has completed. The name of the file is determined by the serial number of the machine and the cycle number.

For example:

The serial number is E00001. The cycle number is 00012.

The file name in the USB stick is 01001200.txt.

The first two numbers represent machine number.

The middle four numbers represent cycle number.

The last two numbers represent error code.

00: no error; 01: error E01

6.7 Retrieve information from a prior cycle

Press PROGRAM repeatedly until you enter the prior program storage screen. This will show the cycle No.

Press the TEMP button to toggle between different cycles.

To print or send details to the USB drive, press the START button. The most recent 20 records are stored.

```
P:000 88      13:08:08
                2008-08-18
```

When viewing printed data records, refer to the diagram below:

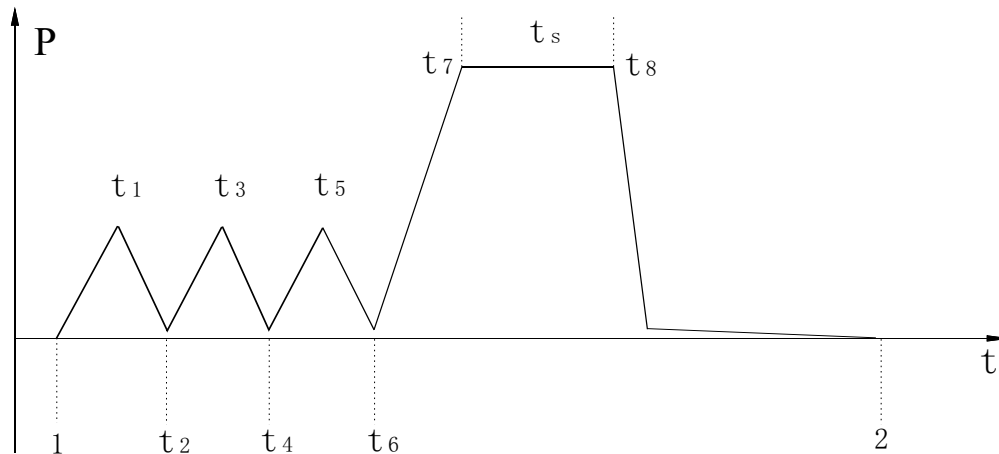

```
=====
Program: WRAPPED
Temperature: 274 F
Pressure:30.5 psi
Dry Time: 03Min
Ster Time: 4.0Min
=====
```

```
-----
      time    temp.  pressure
Start 15:24:20 107.6 F
T1: 15:32:11 158.0 F 07.71psi
T2: 15:36:08 167.5 F 01.42psi
T3: 15:39:21 194.5 F 07.30psi
T4: 15:44:32 094.3 F 01.39psi
T5: 15:47:12 201.7 F 14.91psi
T6: 16:00:11 230.3 F 01.35psi
TS:           274.6 F 32.14psi
Max.Temperature:275.2 F
Min.Temperature:274.1 F
Max.Pressure:33.42psi
Min.Pressure:30.88psi
T7: 16:04:02 275.0 F 32.42psi
T8: 16:06:32 274.6 F 31.05psi
End 16:14:12 172.8 F
=====
```

```
-----
Cycle No: 0005
Ster Value: Success
Date: 2011-01-18
SN:E00001
Operator:
=====
```

```
=====
Program: WRAPPED
Temperature: 274 F
Pressure:30.5 psi
Dry Time: 03Min
Ster Time: 4.0Min
=====
```

```
-----
      time    temp.  pressure
Start 17:34:20 179.6 F
T1: 17:42:11 194.0 F 07.57psi
T2: 17:46:08 185.5 F 01.41psi
T3: 17:49:21 226.9 F 07.75psi
T4: 17:54:32 212.5 F 01.39psi
T5: 00:00:00 000.0 F 000.0psi
T6: 00:00:00 000.0 F 000.0psi
TS:           000.0 F 000.0psi
MAX.Temperature:000.0 F
MIN.Temperature:000.0 F
MAX.Pressure:000.0psi
MIN.Pressure:000.0psi
T7: 00:00:00 000.0 F 000.0psi
T8: 00:00:00 000.0 F 000.0psi
End 17:54:42 212.4 F 01.46psi
=====
```

```
-----
Cycle No: 0007
Ster Value: Failure E01
Date: 2011-01-18
SN:E00001
Operator:
=====
```

7 Maintenance

Frequency	Maintenance Operation
Daily	Clean the door seal
	Clean the external surface
Weekly	Clean the distilled water tank
	Clean the sterilization chamber
Every month (depending on the use)	Clean the filter inside the chamber and tank
Every year	Replace the door seal

7.1 Clean the distilled water tank every week with isopropyl alcohol or a medical disinfectant.

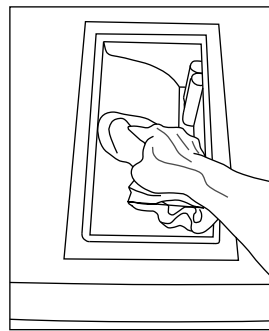

7.2 Clean the chamber weekly.

7.2.1 Remove all trays and the tray rack from the chamber.

7.2.2 Clean the chamber with a smooth cloth saturated with distilled water.

7.2.3 Apply the same procedure for the trays and rack.

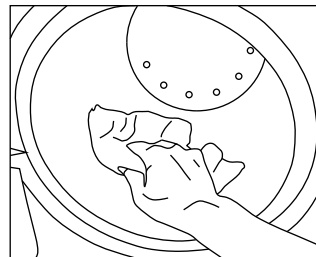

7.3 Clean the door seal

Clean the door seal weekly, with a smooth cloth saturated with the distilled water.

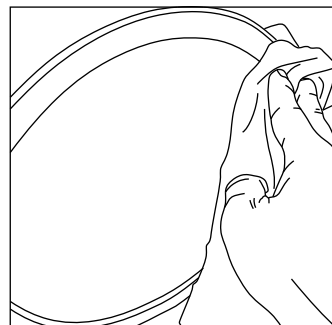
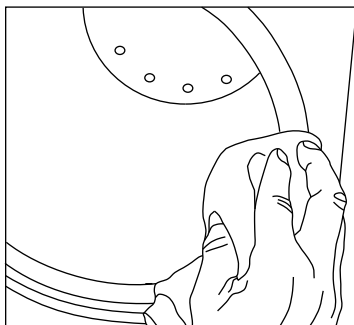

7.4 Door adjustment

On normal circumstance the chamber door does not require adjustments. However, if the seal fails (resulting in steam leaking from the front of the chamber), you may use the included tool to tighten the door seal.

7.4.1 Open the door

7.4.2 Insert the spanner tool in the gap beneath the plastic cover; use the spanner to grip the adjusting nut (Fig 1). Turn the nut counter clockwise as the figure below (Fig 2). This will tighten the sealing plate.

7.4.3 Turn the nut until the sealing plate is tight. If the door knob is too tight, you may also turn the nut clockwise to loosen it.

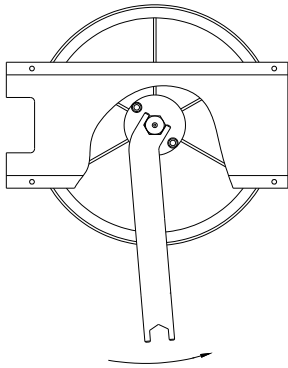

Fig 1

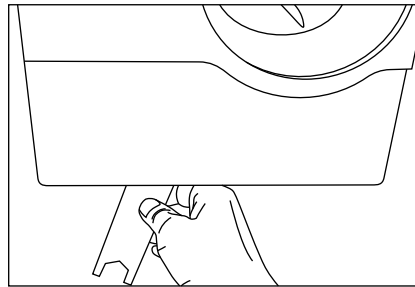
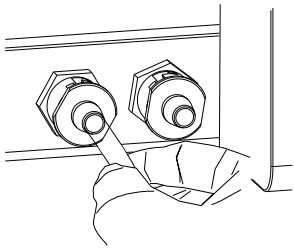
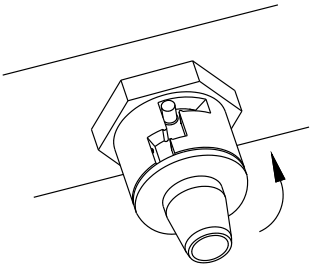
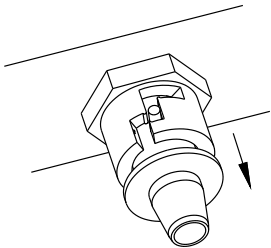
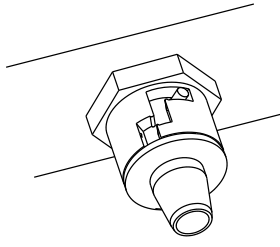

Fig 2

Caution: Never adjust the chamber door while the door is closed.

7.5 The drain valve

 <p>1. Press the included hose on to the drain valve firmly.</p>	 <p>2. Set the drain valve to the open position by turning it counter clockwise.</p>
 <p>3. Pull the drain valve outward, the tank will begin to drain.</p>	 <p>4. After finish draining the tank, push the drain valve inward and turn clockwise into the closed position.</p>

7.6 Replacement of the door seal

7.6.1 Open the chamber door.

7.6.2 Remove the door seal ring carefully by hand.

7.6.3 Clean the door seal ring carefully with a smooth cloth saturated with distilled water.

7.6.4 Moisten the new seal with medical disinfectant or isopropyl alcohol.

7.6.5 Insert the new seal and press in sequence as follows:

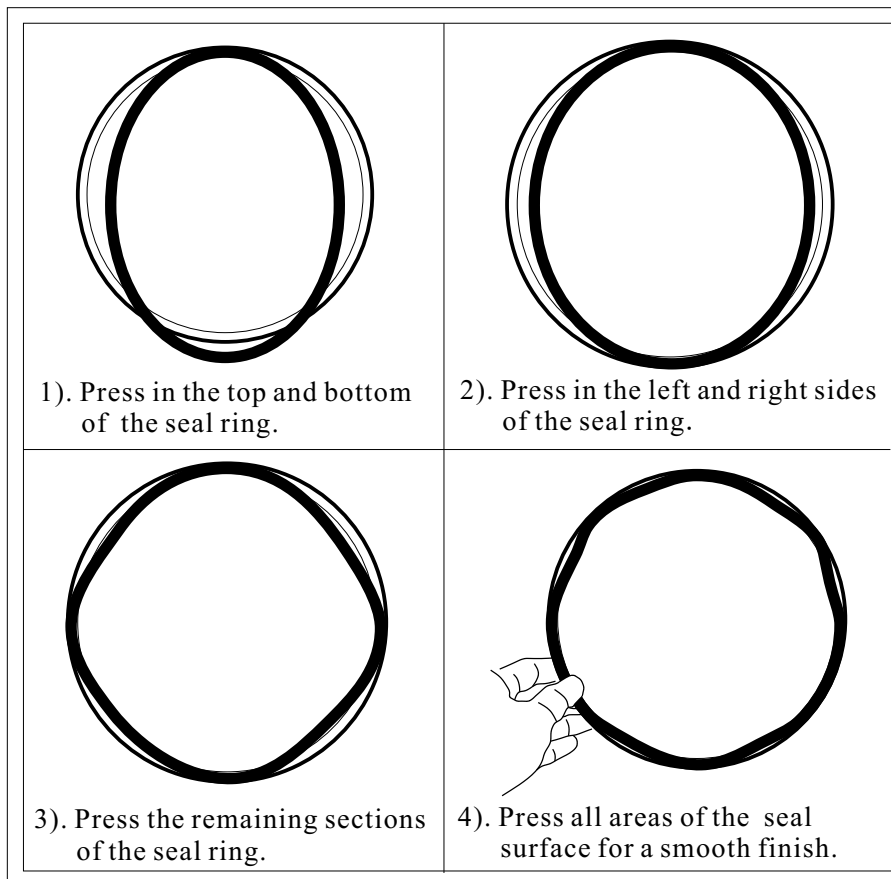

Caution: Please ensure the chamber and the door have cooled prior to replacing the seal ring.

8 Transportation and Storage

8.1 Switch off the sterilizer before transportation or storage. Pull out the plug to let the machine cool down.

8.2 Drain the distilled water tank and the used water tank.

8.3 Conditions for transportation and storage:

Temperature: $-20\text{ }^{\circ}\text{C} \sim +55\text{ }^{\circ}\text{C}$

Relative humidity: $\leq 85\%$

Atmospheric pressure: $50\text{kPa} \sim 106\text{kPa}$

9 Error codes

Code	Description	Proposed solution
E1	Steam generator temperature sensor error	Power off & run a new cycle Contact your Supplier if error persists
E2	Inner temperature sensor error	Power off & run a new cycle Contact your Supplier if error persists
E3	Temperature sensor of chamber wall error	Carefully ensure that the chamber wall is heated. If not contact your supplier
E4	Fail to rise temperature	Check to ensure that the used water valve is fully closed.
E5	Fail to release the pressure	Power off & run a new cycle Contact your Supplier if error persists
E6	Door has opened during the cycle	Make sure you have turned the door handle to the max. Position or check the door switch
E9	Failure to hold temperature	Ensure the distilled water tank isn't empty Check the inner temperature sensor Check the door for leaking
E11	Failure to preheat the steam generator	Check the steam generator heater Check the steam generator protector
E12	Failure to preheat the chamber	Check the chamber heater Check chamber protector
E20	Program manually interrupted	Shut off the power and restart the power

10 Safety devices

(1) Main fuses

Protect the instrument against possible failures of the heating resistor .

Action: Interruption of the electric power supply.

(2) Thermal cutouts on the main transformer windings

Protection against possible short circuit and main transformer primary winding overheating .

Action: Temporary interruption of the winding.

(3) Safety valve

Protection against possible sterilization chamber over-pressure .

Action: release of the steam and restoration of the safely pressure.

(4) Safety micro-switch for the door status

Comparison for the correct closing position of the door .

Action: signal of wrong position of the door.

(5) Door safety lock

Protection against accidental opening of the door.

Action: Impediment of the accidental opening of the door during the program.

(6) Self-leveling hydraulic system

Hydraulic system for the natural pressure leveling in case of manual cycle interruption, Alarm or black-out .

Action: automatic restoration of the atmospheric pressure inside chamber.





APPENDIX 1

Water Properties/Characteristics

DESCRIPTION	FEED WATER	CONDENSATE
Evaporate residue	≤10 mg/l	≤1.0 mg/kg
Silicium oxide SiO_2	≤1 mg/l	≤0.1 mg/kg
Iron	≤0.2 mg/l	≤0.1 mg/kg
Cadmium	≤0.005 mg/l	≤0.05 mg/kg
Lead	≤0.05 mg/l	≤0.1 mg/kg
Rest of heavy metals, excluding iron, cadmium, lead	≤0.1 mg/l	≤0.1 mg/kg
Chloride	≤2 mg/l	≤0.1 mg/l
Phosphates	≤0.5 mg/l	≤0.1 mg/l
Conductivity (at 20°C)	≤15 $\mu\text{s/cm}$	≤3 $\mu\text{s/cm}$
pH value	5–7.5	5–7
Appearance	Colorless, clean, without sediments	Colorless, clean, without sediments
Hardness	≤0.02 mmol/l	≤0.02 mmol/l

APPENDIX 2

DIAGRAMS OF THE STERILIZATION PROGRAMS

PROGRAM	Temperature (°F)	Pressure (psi)	Holding time (min)	Total time (min)	TYPE	Max. Load (kg)	Max. Load per tray (kg)
 UNWRAPPED (SOLID)	274	30.5	4	14-25	Unwrapped solid material	2.00	0.60
	250	16.0	20	25-40			
 LIQUID	274	30.5	10	25-50	Liquid	0.60	0.20
	250	16.0	30	30-55			
 WRAPPED	274	30.5	4	25-45	Unwrapped porous material	1.50	0.60
	250	16.0	20	25-50	Single-wrapped solid or hollow material	2.00	0.60
 EXTENSIVE (PRION)	274	30.5	18	30-50	Unwrapped porous material	0.50	0.15
					Single-wrapped porous material	0.35	0.10
					Dual-wrapped porous material	0.25	0.10
					Single-wrapped hollow material	1.50	0.50
					Dual-wrapped solid and hollow material	1.00	0.30
 DRYING	—	—	—	1-20	—	—	—

The max. temperature of the 274°F sterilization cycle is 279°F

The max. temperature of the 250°F sterilization cycle is 256°F

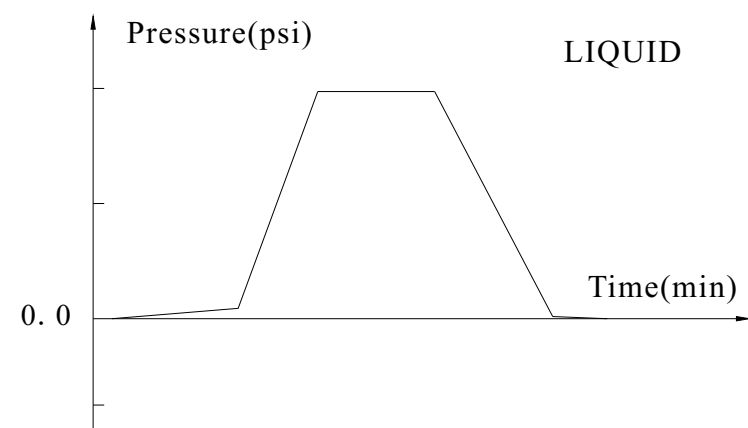
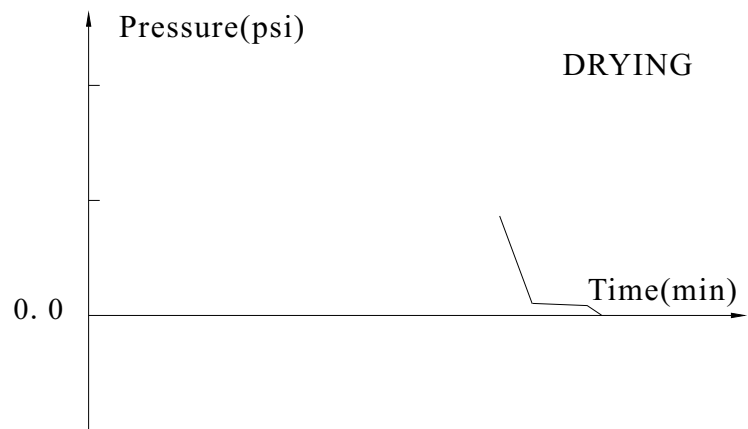
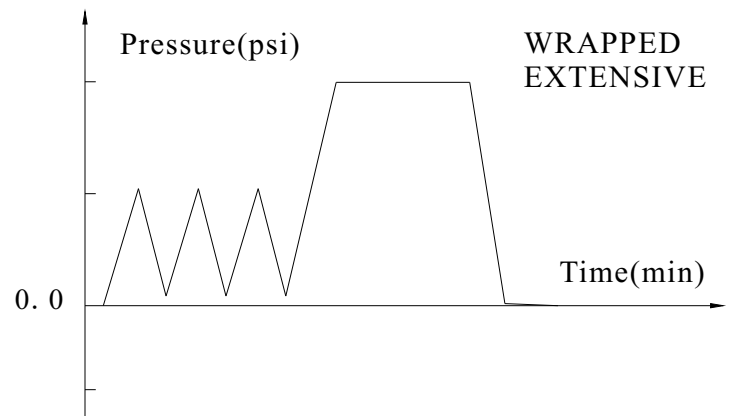
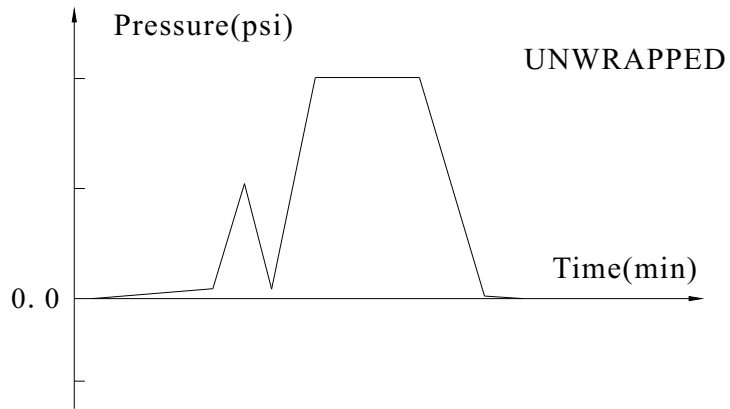

WIRING DIAGRAM

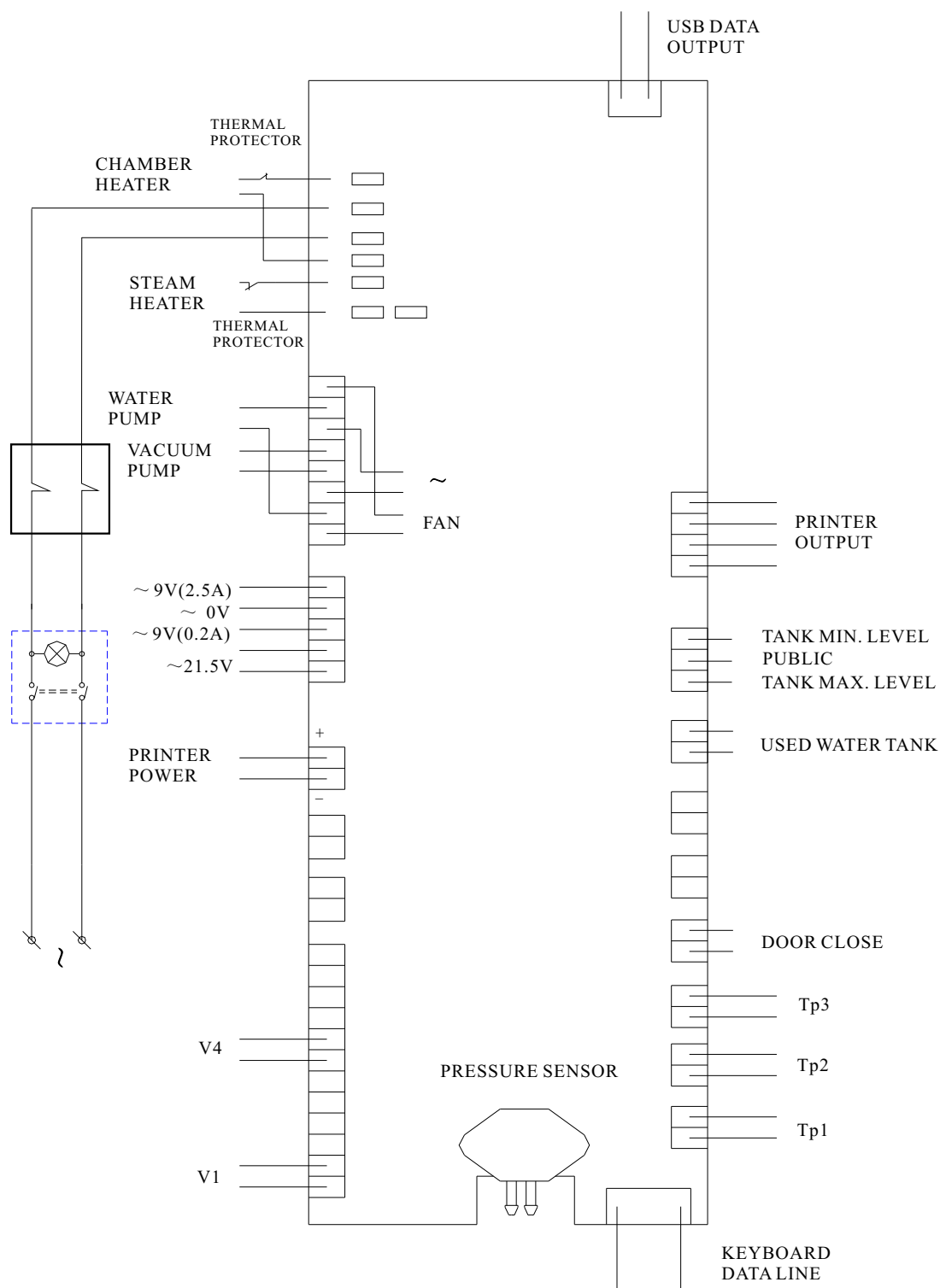

- TP1: Steam generator temperature sensor
- TP2: Inner temperature sensor
- TP3: Temperature sensor of chamber wall
- V1: Air release valve
- V4: Water release valve

HYDRAULIC DRAWING

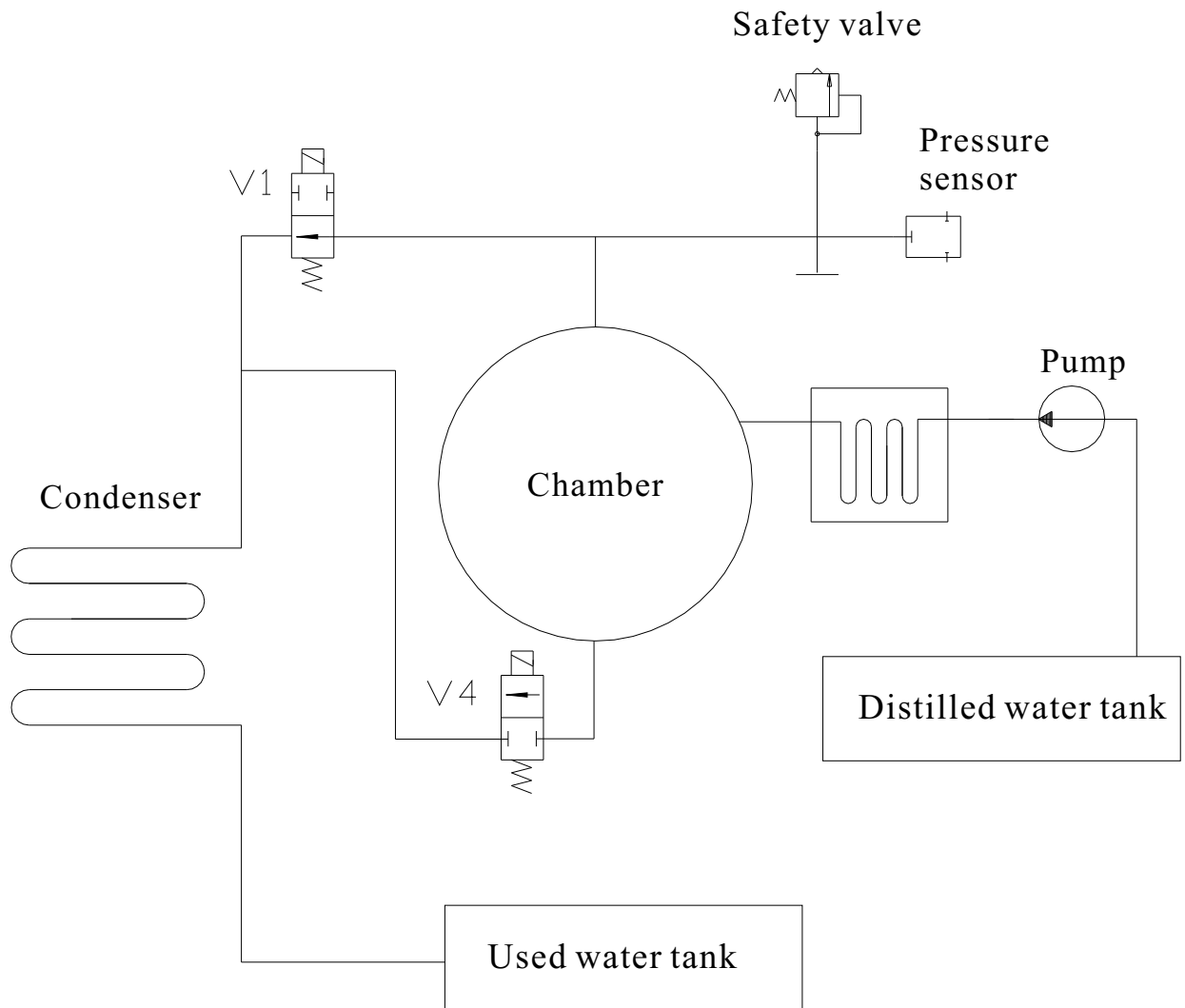

V1: Air release valve
V4: Water release valve